



BEMLIGHT



BEMLIGHT

BEMLIGHT
1, rue Cachot- 95710 CHAUSSY
TEL 01.34.50.53.45
Mail : contact@bemlight.fr
www.bemlight.fr

SOMMAIRE:

ENCASTRE: P.4	SWING NEXT RECESSED.....:P.26
LUZERNA AVANT.....: P.5	LIBERTAD.....:P.26
NASSEL AVANT.....: P.5	LIBERTAD ADJ.....:P.27
NASSEL.....: P.6	OSAKA.....:P.27
SEALED.....: P.6	ANDORRA.....:P.28
ITALI' UGR.....: P.7	ITALY.....:P.28
ITALI' UGR IP 66.....: P.7	SIRA.....:P.29-30
PANEL CUBIC.....: P.8	ANNECY.....:P.30
PARIS.....: P.8	SIRA TRIMLESS.....:P.31
BERLIN II.....: P.9	LISA.....:P.32
MARSEILLE.....: P.9	LUNA.....:P.32
LYON.....: P.10	ZORA.....:P.33
MONACO.....: P.10	SENSE.....:P.34-38
DOWNLIGHT: P.11	CLUB.....:P.38-45
ELIT.....: P.12	VISION.....:P.46
ELIT MINI.....: P.12	MINUX.....:P.46-47
ELIT MICRO.....: P.13	KENZO.....:P.47-48
HAT.....: P.13	FUSION.....:P.48-55
HAT MINI.....: P.14	NAOS.....:P.56
HAT MICRO.....: P.14	PROFILE P.57
POLART.....: P.15	TRAZZO AVANT.....:P.58-59
POLART Q.....: P.15	LINNEA.....:P.60
SPICA.....: P.16	SLIM.....:P.61
BASSE LUMINANCE.....: P.16	MADERA.....:P.62
NEW WHITE.....: P.17	4031-4032-4033.....:P.63/66
BOSTON.....: P.17	4041-4042-4043.....:P.64/66
NORWAY.....: P.18	4051-4052-4053.....:P.65-66
BAHAMAS.....: P.19	4530-4531 4540-4541 4550-4551.....:P.67-68
LONDON.....: P.19	5572.....:P.69
TAKEO.....: P.20	5050.....:P.70
SPOT: P.21	LINEA.....:P.71-72
IR & IQ.....: P.22	PLAFONNIER P.73
HOLLOW LED.....:P.23-24	HAT S.....:P.74
RAFTER POINTS LED TRIM RECESSEY.....:P.25	ELIT S.....:P.74

SOMMAIRE:

CYRE.....: P.75	STILE NEXT POST.....: P.97
BLOS ROUND.....: P.75	<u>ECLAIRAGE PUBLIC P.98</u>
TUBA 55.....: P.76	ARISA TOP.....: P.99
TUBA 111.....: P.76	STILE NEXT POST.....: P.99
MINI RING RIM.....: P.77	AVATAR.....: P.100
BIG SIZE NEXT ROUND.....: P.77	SFERA.....: P.100
<u>INDUSTRIELLE & SPORTIF P.78</u>	IRCANA.....: P.101
ETANCHE HERMETIC AVANT.....: P.79	ELLP.....: P.102-103
BLOK AVANT.....: P.79	TOULOUSE.....: P.104
AKEN.....: P.80	GRENOBLE.....: P.105
KELA.....: P.80	NANTES.....: P.105-106
TUBE70.....: P.81	<u>ENCASTRE AU SOL P.107</u>
TOULOUSE.....: P.81	CNC49.....: P.108
NANTES.....: P.82	CNC99.....: P.109
TUBE 40.....: P.83	CNC120.....: P.110
GURU.....: P.84-P.87	CNC150.....: P.110
<u>EXTERIEUR P.88</u>	CNC35.....: P.111
IBIZA & MARBELLA.....: P.89	AGO GARDEN.....: P.112
MALAGA VALENCE.....: P.90	AGO GARDEN POWER.....: P.112
TONDA.....: P.91	SWING SPOT.....: P.113
DODO.....: P.91	SWING SPOT POWER.....: P.113
BOSS.....: P.92	
ART.....: P.92-93	
AGO.....: P.93	
PISE.....: P.94	
PALERME.....: P.94	
GENES.....: P.94	
SARDAIGNE.....: P.95	
TOURS.....: P.95	
AGO.....: P.96	
LINE POST.....: P.97	

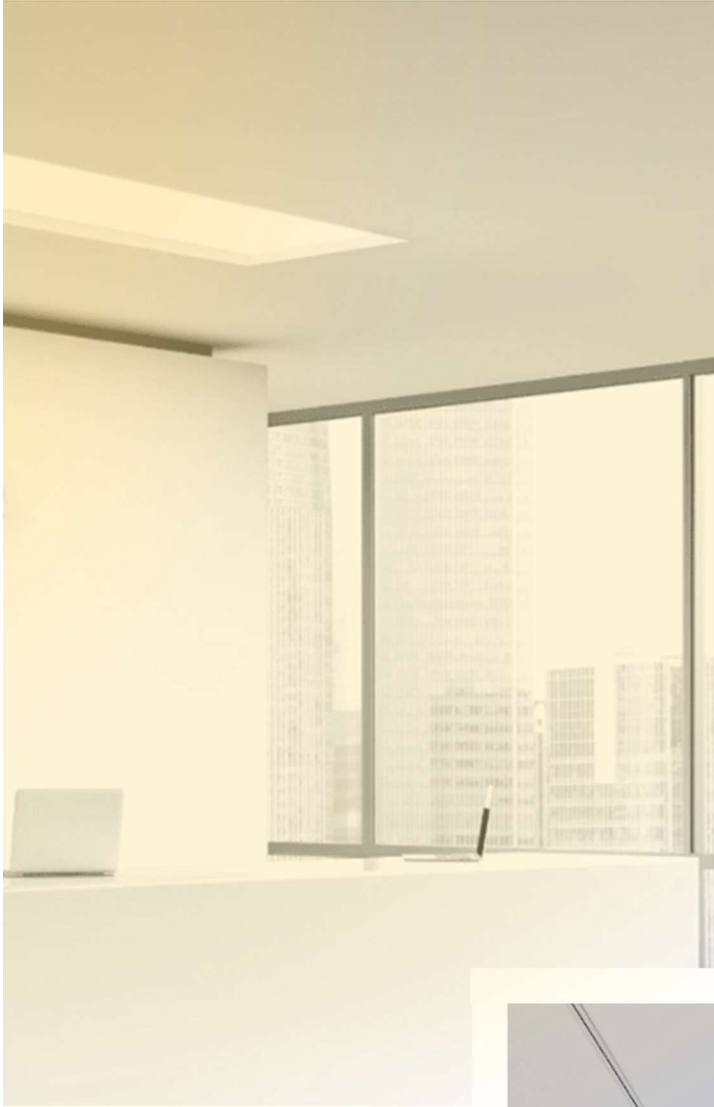

ENCASTRE

LUZERNA AVANT



<u>Puissance</u>	32-64W ⚡
<u>Couleur de Température (K)</u>	TW 2700-6500 3000 4000 5000
<u>Lumens</u>	4320 – 10280Lm 💡
<u>Dimensions</u>	600x600 1200x300 1200x600mm
<u>Options</u>	DALI ✓ DALI/PUSH ✓

Référence +
Dali = D
(BNORLX33DB)

UGR 19
Diffuseur
MicroPrism

UGR 16
Diffuseur
Opal

IP
20-44

IRC
>80

L70B10
50.000h

References	Puissances	K	Lumens	Dimensions
BNORLX33B	1X32W	3000K	4320 Lm	600x600
BNORLX34B	1X32W	4000K	5140 Lm	600x600
BNORLX35B	1X32W	5000K	5140 Lm	600x600
BNORLX43B	1X32W	3000K	4320 Lm	1200x300
BNORLX44B	1X32W	4000K	5140 Lm	1200x300
BNORLX45B	1X32W	5000K	5140 Lm	1200x300
BNORLX53B	1X64W	3000K	8640 Lm	1200x600
BNORLX54B	1X64W	4000K	10280 Lm	1200x600
BNORLX55B	1X64W	5000K	10280 Lm	1200x600

NASSEL AVANT

<u>Puissance</u>	25-27W ⚡
<u>Couleur de Température (K)</u>	2700-5600 2700-6500 3000 4000
<u>Lumens</u>	3345 – 5000Lm 💡
<u>Dimensions</u>	600x600mm *sur-mesure
<u>Options</u>	DALI ✓ DALI/PUSH ✓



Référence +
Dali = D
(NX33DB)

UGR
16

IP
44

IRC
>80

L70B10
72.000h

References	Puissances	K	Lumens	Dimensions
BNORNX33B	1X27W	3000K	4800 Lm	600x600
BNORNX34B	1X27W	4000K	5000 Lm	600x600

NASSEL



<u>Puissance</u>	24-48W ⚡
<u>Couleur de Température (K)</u>	3000K 4000K
<u>Lumens</u>	3400-7400 Lm
<u>Dimensions</u>	600x600 1200x300 1200x600mm
<u>Options</u>	DALI ✓ DALI/PUSH ✓

Référence +
Dali = D
(BNONS23DB)

UGR
16

IP
20-44

IRC
>80

L70B10
60.000h

<u>References</u>	<u>Puissances</u>	<u>K</u>	<u>Lumens</u>	<u>Dimensions</u>
BNORNS23B	1X24W	3000K	3400 Lm	600x600
BNORNS24B	1X24W	4000K	3700 Lm	600x600
BNORNS33B	1X36W	3000K	5100 Lm	600x600
BNORNS34B	1X36W	4000K	5550 Lm	600x600
BNORNS43B	1X48W	3000K	6800 Lm	1200x300
BNORNS44B	1X48W	4000K	7400 Lm	1200x300
BNORNS53B	1X48W	3000K	6800 Lm	1200x600
BNORNS53B	1X48W	4000K	7400 Lm	1200x600

SEALED

<u>Puissance</u>	24-48W ⚡
<u>Couleur de Température (K)</u>	3000K 4000K TW
<u>Lumens</u>	3400-7400 Lm
<u>Dimensions</u>	600x600 1200x300 1200x600mm
<u>Options</u>	DALI ✓ DALI/PUSH ✓

UGR
16

IP
65

IRC
>80

L70B10
60.000h



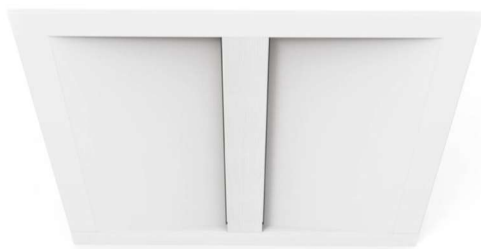

Puissance	13-46W ⚡
Couleur de Température (K)	2700K 3000K *Sur demande 4000K 5000K 6000K 🌈
Lumens	1590-3200 Lm 💡
Dimensions	300x600 600x600 1200x300 1200x600 ^{*Sur-mesure} 📏
Options	DALI ✓ DALI/PUSH ✓ ⚙️

Référence +
Dali = DL
(BNOITM804DL)
Variante= VL
(BNOITM804VL)

UGR 19
IP 44
IRC >80
IRC >90
L90B10 60.000h
L70B50 100.000h

References	Puissances	K	Lumens	Dimensions
BIDEITM804	13,5W	3K/4K/6000K	1600 Lm	300x600
BIDEITM904	13,5W	3K/4K/6000K	1475 Lm	300x600
BIDEITM807	26,5W	3K/4K/6000K	3200 Lm	600x600
BIDEITM907	26,5W	3K/4K/6000K	2950 Lm	600x600
BIDEITM805	25,5W	3K/4K/6000K	3200 Lm	1200x300
BIDEITM905	25,5W	3K/4K/6000K	2950 Lm	1200x300
BIDEITM808	46W	3K/4K/6000K	5740 Lm	1200x600
BIDEITM908	46W	3K/4K/6000K	5200 Lm	1200x600

ITALI' UGR IP65



Puissance	26,5-46W ⚡
Couleur de Température (K)	2700K 3000K *Sur demande 4000K 5000K 6000K 🌈
Lumens	2640-5340 Lm 💡
Dimensions	600x600 1200x300 1200x600mm ^{*Sur-mesure} 📏
Options	DALI ✓ DALI/PUSH ✓ ⚙️

Référence +
Dali = DL
(BNOITPM807DL)
Variante= VL
(BNOITPM807VL)

UGR 19
IP 65
IRC >80
IRC >90
L90B10 60.000h
L70B50 100.000h

References	Puissances	K	Lumens	Dimensions
BIDEITPM807	26,5W	3K/4K/6000K	2980 Lm	600x600
BIDEITPM907	26,5W	3K/4K/6000K	2640 Lm	600x600
BIDEITPM805	26,5W	3K/4K/6000K	2980 Lm	300x1200
BIDEITPM905	26,5W	3K/4K/6000K	2640 Lm	300x1200
BIDEITPM808	46W	3K/4K/6000K	5340 Lm	1200x600
BIDEITPM908	46W	3K/4K/6000K	4700 Lm	1200x600

ENCASTRE

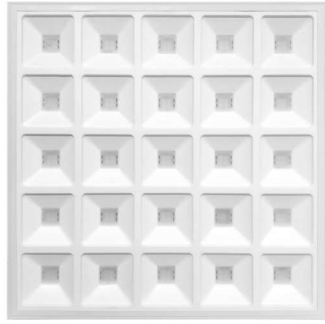

PANEL CUBIC

Puissance

| 36W ⚡

Couleur de Température (K)

| 4000K 🌞

Lumens

| 4370 Lm 💡

Dimensions

| 600x600 📏

Options

| DALI ✓ | DALI/PUSH ✓ ⚡

UGR
17

IP
44

IRC
80

L80B10
50.000h

References	Puissances	K	Lumens	Dimensions
BSE2200 01 36 84	36W	4000K	4370 Lm	600x600
BSE2201 01 36 84	36W	4000K	4370 Lm	600x600

PARIS

Puissance

| 40W ⚡

Couleur de Température (K)

| 3000K | 4000K | 6000K 🌞

Lumens

| 4000 Lm 💡

Dimensions

| 600x600 📏

Options

| DALI ✓ | DALI/PUSH ✓ ⚡



DRIVER
30W

UGR
<19

IP
20

IRC
>80

L80B10
50.000h

References	Puissances	K	Lumens	Dimensions
BID899003	40W	3000K	4000 Lm	600x600
BID899004	40W	4000K	4000 Lm	600x600
BID899004	40W	6000K	4000 Lm	600x600



BERLIN II

<u>Puissance</u>	36W ⚡
<u>Couleur de Température (K)</u>	3000K 4000K 6000K 🌞
<u>Lumens</u>	4370 Lm 💡
<u>Dimensions</u>	1200x300 📏
<u>Options</u>	DALI ✓ DALI/PUSH ✓ ⚙️

DRIVER
30W

UGR
<19

IP
20

IRC
>80

L80B10
50.000h

<u>References</u>	<u>Puissances</u>	<u>K</u>	<u>Lumens</u>	<u>Dimensions</u>
BID899025	40W	3000K	4000 Lm	1200x300
BID899026	40W	4000K	4000 Lm	1200x300
BID899027	40W	6000K	4000 Lm	1200x300

MARSEILLE

<u>Puissance</u>	40W ⚡
<u>Couleur de Température (K)</u>	4000K 🌞
<u>Lumens</u>	4000 Lm 💡
<u>Dimensions</u>	1200x300 📏
<u>Options</u>	DALI ✓ DALI/PUSH ✓ ⚙️



UGR
<19

IP
20

IRC
>80

L80B10
50.000h

DRIVER
30W

<u>References</u>	<u>Puissances</u>	<u>K</u>	<u>Lumens</u>	<u>Dimensions</u>
BID899018	40W	4000K	4000 Lm	680x680



LYON

<u>Puissance</u>	40W ⚡
<u>Couleur de Température (K)</u>	3000K 4000K
<u>Lumens</u>	4000 Lm
<u>Dimensions</u>	600x600
<u>Options</u>	DALI ✓ DALI/PUSH ✓

DRIVER
30W

UGR
<19

IP
20

IRC
>80

L80B10
50.000h

<u>References</u>	<u>Puissances</u>	<u>K</u>	<u>Lumens</u>	<u>Dimensions</u>
BID899029	40W	3000K	4000 Lm	600x600
BID899028	40W	4000K	4000 Lm	600x600

MONACO

<u>Puissance</u>	40W ⚡
<u>Couleur de Température (K)</u>	3000K 4000K 3CTT
<u>Lumens</u>	4000 Lm
<u>Dimensions</u>	600x600
<u>Options</u>	DALI ✓ DALI/PUSH ✓

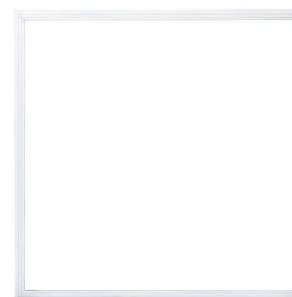

MONACO II



UGR
<19

IP
20

IRC
>80

L80B10
50.000h

<u>References</u>	<u>Puissances</u>	<u>K</u>	<u>Lumens</u>	<u>Dimensions</u>
BID831163	40W	3000K	4000 Lm	600x600
BID831164	40W	4000K	4000 Lm	600x600
BID576004	40W	3CCT	4000 Lm	600x600



DOWNLIGHT

DOWNLIGHT

ELIT



<u>Puissance</u>	11,8-54,6W ⚡
<u>Couleur de Température (K)</u>	3000K 4000K
<u>Lumens</u>	1930-8450 Lm
<u>Dimensions</u>	218mm
<u>Options</u>	DALI ✓ DALI/PUSH ✓

Sans diffuseur = (Rien (IP20))

Opale = O

Transparent= T

Noir = N

Gris = G

Blanc = B

<u>UGR</u> 19	<u>IP</u> 20-54	<u>IRC</u> >80	<u>L70B10</u> 60.000h
------------------	--------------------	-------------------	--------------------------

References	Puissances	K	Lumens	Dimensions
BNOREL23XX	11,8W	3000K	1930 Lm	Ø218mm
BNOREL24XX	11,8W	4000K	2050 Lm	Ø218mm
BNOREL33XX	17,4W	3000K	2650 Lm	Ø218mm
BNOREL34XX	17,4W	4000K	2850 Lm	Ø218mm
BNOREL43XX	25,1W	3000K	3580 Lm	Ø218mm
BNOREL44XX	25,1W	4000K	3780 Lm	Ø218mm
BNOREL63XX	35,2W	3000K	5800 Lm	Ø218mm
BNOREL64XX	35,2W	4000K	6100 Lm	Ø218mm
BNOREL83XX	54,6W	3000K	8020 Lm	Ø218mm
BNOREL83XX	54,6W	4000K	8450 Lm	Ø218mm

ELIT MINI

<u>Puissance</u>	14W ⚡
<u>Couleur de Température (K)</u>	3000K 4000K
<u>Lumens</u>	1350-1490 Lm
<u>Dimensions</u>	170mm
<u>Options</u>	DALI ✓ DALI/PUSH ✓



Sans diffuseur = (Rien (IP20))

Opale = O

Transparent= T

Noir = N

Gris = G

Blanc = B

<u>UGR</u> 19	<u>IP</u> 20-54	<u>IRC</u> >80	<u>L70B10</u> 60.000h
------------------	--------------------	-------------------	--------------------------

References	Puissances	K	Lumens	Dimensions
BNOREM13XX	14W	3000K	1350 Lm	Ø218mm
BNOREM14XX	14W	4000K	1490 Lm	Ø218mm

DOWNLIGHT



Sans diffuseur = (Rien (IP20))

Opale = O

Transparent= T

Noir = N

Gris = G

Blanc = B

ELIT MICRO

<u>Puissance</u>	6,4W ⚡
<u>Couleur de Température (K)</u>	3000K 4000K
<u>Lumens</u>	760-885 Lm
<u>Dimensions</u>	78mm
<u>Options</u>	DALI ✓ DALI/PUSH ✓

<u>UGR</u> 19	<u>IP</u> 20-54	<u>IRC</u> >80	<u>L70B10</u> 60.000h
------------------	--------------------	-------------------	--------------------------

<u>References</u>	<u>Puissances</u>	<u>K</u>	<u>Lumens</u>	<u>Dimensions</u>
BNOREP03XX	6,4W	3000K	760 Lm	Ø78mm
BNOREL24XX	6,4W	4000K	885 Lm	Ø78mm

HAT

<u>Puissance</u>	13-20,5W ⚡
<u>Couleur de Température (K)</u>	3000K 4000K 5000K 6000K
<u>Lumens</u>	1500-2435 Lm
<u>Dimensions</u>	210mm
<u>Options</u>	DALI ✓ DALI/PUSH ✓



Noir = N
Gris = G
Blanc = B

<u>UGR</u> 22	<u>IP</u> 20-54	<u>IRC</u> >80	<u>L70B10</u> 50.000h	<u>L70B10</u> 72.000h
------------------	--------------------	-------------------	--------------------------	--------------------------

<u>References</u>	<u>Puissances</u>	<u>K</u>	<u>Lumens</u>	<u>Dimensions</u>
BNOREH13X	13W	3000K	1500 Lm	Ø210mm
BNOREH14X	13W	4000K	1600 Lm	Ø210mm
BNOREH15X	13W	5000K	1625 Lm	Ø210mm
BNOREH16X	13W	6000K	1625 Lm	Ø210mm
BNOREH23X	20,5W	3000K	2300 Lm	Ø210mm
BNOREH23X	20,5W	4000K	2400 Lm	Ø210mm
BNOREH23X	20,5W	5000K	2430 Lm	Ø210mm
BNOREH23X	20,5W	6000K	2435 Lm	Ø210mm

HAT MINI



<u>Puissance</u>	10,9W ⚡
<u>Couleur de Température (K)</u>	3000K 4000K 5000K 6000K
<u>Lumens</u>	1400-1520 Lm 💡
<u>Dimensions</u>	135mm (⊘)
<u>Options</u>	DALI ✓ DALI/PUSH ✓ ⚡

Noir = N
Gris = G
Blanc = B

<u>UGR</u> 22	<u>IP</u> 20-54	<u>IRC</u> >80	<u>L70B10</u> 72.000h
------------------	--------------------	-------------------	--------------------------

<u>References</u>	<u>Puissances</u>	<u>K</u>	<u>Lumens</u>	<u>Dimensions</u>
BNOREHM13X	10,9W	3000K	1400 Lm	Ø135mm
BNOREHM14X	10,9W	4000K	1500 Lm	Ø135mm
BNOREHM15X	10,9W	5000K	1520 Lm	Ø135mm
BNOREHM16X	10,9W	6000K	1520 Lm	Ø135mm

HAT MICRO

<u>Puissance</u>	4,8W ⚡
<u>Couleur de Température (K)</u>	3000K 4000K 5000K 6000K
<u>Lumens</u>	460-510 Lm 💡
<u>Dimensions</u>	100mm (⊘)
<u>Options</u>	DALI ✓ DALI/PUSH ✓ ⚡



Noir = N
Gris = G
Blanc = B

<u>UGR</u> 22	<u>IP</u> 20-54	<u>IRC</u> >80	<u>L70B10</u> 50.000h
------------------	--------------------	-------------------	--------------------------

<u>References</u>	<u>Puissances</u>	<u>K</u>	<u>Lumens</u>	<u>Dimensions</u>
BNOREHP03X	4,8W	3000K	460 Lm	Ø100mm
BNOREHP04X	4,8W	4000K	500 Lm	Ø100mm
BNOREHP05X	4,8W	5000K	510 Lm	Ø100mm
BNOREHP06X	4,8W	6000K	510 Lm	Ø100mm

POLART



<u>Puissance</u>	18W ⚡
<u>Couleur de Température (K)</u>	3000K 4000K 5000K
<u>Lumens</u>	2613-2790 Lm 💡
<u>Dimensions</u>	223mm (⊘)
<u>Options</u>	DALI ✓ DALI/PUSH ✓ ⚡

UGR
22

IP
20-50

IRC
>80

L80B10
72.000h

<u>References</u>	<u>Puissances</u>	<u>K</u>	<u>Lumens</u>	<u>Dimensions</u>
BNORPO23B	18W	3000K	2613 Lm	Ø223mm
BNORPO24B	18W	4000K	2750 Lm	Ø223mm
BNORPO25B	18W	5000K	2790 Lm	Ø223mm
BNORPO2XB	18W	3K/4K/5000K	2750 Lm	Ø223mm

POLART Q

<u>Puissance</u>	17W ⚡
<u>Couleur de Température (K)</u>	3000K 4000K 5000K
<u>Lumens</u>	2613-2790 Lm 💡
<u>Dimensions</u>	223x223mm (⊠)
<u>Options</u>	DALI ✓ DALI/PUSH ✓ ⚡

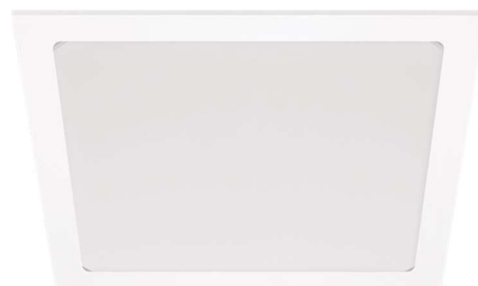

UGR
22

IP
20-50

IRC
>80

L80B10
72.000h

<u>References</u>	<u>Puissances</u>	<u>K</u>	<u>Lumens</u>	<u>Dimensions</u>
BNORPOQ23B	17W	3000K	2613 Lm	223x223mm
BNORPOQ24B	17W	4000K	2750 Lm	223x223mm
BNORPOQ25B	17W	5000K	2790 Lm	223x223mm
BNORPOQ2XB	17W	3K/4K/5000K	2750 Lm	223x223mm

SPICA



<u>Puissance</u>	10-25W ⚡
<u>Couleur de Température (K) CCT</u>	
<u>Lumens</u>	860-2130 Lm 💡
<u>Dimensions</u>	Ø150mm Ø200mm
<u>Options</u>	DALI ✗ DALI/PUSH ✗

IP
20

IRC
>80

L70B10
20.000h

<u>References</u>	<u>Puissances</u>	<u>K</u>	<u>Lumens</u>	<u>Dimensions</u>
BLAE998962	10W	CCT	860 Lm	Ø150mm
BLAE998979	18W	CCT	1550 Lm	Ø200mm
BLAE998986	25W	CCT	2130 Lm	Ø200mm

BASSE LUMINANCE

<u>Puissance</u>	18-30W ⚡
<u>Couleur de Température (K)</u>	3000K 4000K 6500K
<u>Lumens</u>	1650-2800 Lm 💡
<u>Dimensions</u>	Ø220mm
<u>Options</u>	DALI ✓ DALI/PUSH ✓



UGR
<19

IP
20-44

IRC
>80

L70B10
30.000h

<u>References</u>	<u>Puissances</u>	<u>K</u>	<u>Lumens</u>	<u>Dimensions</u>
BLAE992786	18W	3000K	1650 Lm	Ø220mm
BLAE992793	18W	4000K	1750 Lm	Ø220mm
BLAE992809	18W	6500K	1750 Lm	Ø220mm
BLAE992816	30W	3000K	2600 Lm	Ø220mm
BLAE992823	30W	4000K	2800 Lm	Ø220mm
BLAE992830	30W	4000K	2800 Lm	Ø220mm

NEW WHITE



<u>Puissance</u>	11-26,5W ⚡
<u>Couleur de Température (K)</u>	3000K 4000K
<u>Lumens</u>	1465-3275 Lm
<u>Dimensions</u>	Ø150mm Ø200mm Ø230mm
<u>Options</u>	DALI ✓ DALI/PUSH ✓

DALI = DL
 PUSH DIM = PD
 3000k = W
 4000k = N

<u>IP</u> 44	<u>IRC</u> >80	<u>IRC</u> >90	<u>L90B10</u> 60.000h	<u>L70B50</u> 100.000h
-----------------	-------------------	-------------------	--------------------------	---------------------------

<u>References</u>	<u>Puissances</u>	<u>K</u>	<u>Lumens</u>	<u>Dimensions</u>
BIDENWI150PXXX	11-22W	3000K/4000K	1465-2560 Lm	Ø150mm
BIDENWI15240PXXX	26,5W	3000K/4000K	3275 Lm	Ø150mm
BIDENWI200PXXX	11-22W	3000K/4000K	1465-2560 Lm	Ø200mm
BIDENWI20240PXXX	26,5W	3000K/4000K	3275 Lm	Ø200mm
BIDENWI230PXXX	11-22W	3000K/4000K	1465-2560 Lm	Ø230mm
BIDENWI230PXXX	26,5W	3000K/4000K	1465 Lm	Ø230mm

BOSTON

<u>Puissance</u>	10-35W ⚡
<u>Couleur de Température (K)</u>	2,7K-3,2K-4K
<u>Lumens</u>	800-2900 Lm
<u>Dimensions</u>	Ø114mm Ø174mm Ø195mm
<u>Options</u>	DALI ✓ DALI/PUSH ✓



<u>UGR</u> <19	<u>IP</u> 64	<u>IRC</u> >90	<u>L70B10</u> 50.000h
-------------------	-----------------	-------------------	--------------------------

<u>References</u>	<u>Puissances</u>	<u>K</u>	<u>Lumens</u>	<u>Dimensions</u>
BHOF1.1145.0118	10W	2,7K-3,2K-4K	800-905-870 Lm	Ø114mm
BHOF1.1146.0118	20W	2,7K-3,2K-4K	1540-1730-1680 Lm	Ø174mm
BHOF1.1147.0118	28W	2,7K-3,2K-4K	2275-2535-2520 Lm	Ø232mm
BHOF1.1147.0118	35W	2,7K-3,2K-4K	2565-2900-2730 Lm	Ø232mm

NORWAY

IP
40

IRC
>80

L70B10
40.000h

Puissance | 9-20W ⚡

Couleur de Température (K) | 2700K | 3000K | 4000K 🌈

Lumens | 700-1720 Lm 💡

Dimensions | Ø110mm | Ø154mm | Ø175mm
| 110X110 | 145X145 | 170X170mm

Options | DALI ✓ | DALI/PUSH ✓ ⚙️



DALI = DL
PUSH DIM = PD

References	Puissances	K	Lumens	Dimensions
BHOF1.1110.0111	9W	2700K	700 Lm	Ø120mm
BHOF1.1110.0112	9W	3000K	730 Lm	Ø120mm
BHOF1.1110.0114	9W	4000K	765 Lm	Ø120mm
BHOF1.1111.0112	15W	3000K	1235 Lm	Ø154mm
BHOF1.1111.0114	15W	4000K	1300 Lm	Ø154mm
BHOF1.1112.0112	20W	3000K	1660 Lm	Ø175mm
BHOF1.1112.0114	20W	4000K	1720 Lm	Ø175mm
BHOF1.1115.0111	9W	2700K	705 Lm	110x110mm
BHOF1.1115.0112	9W	3000K	735 Lm	110x110mm
BHOF1.1115.0114	9W	4000K	770 Lm	110x110mm
BHOF1.1116.0112	15W	3000K	1260 Lm	145x145mm
BHOF1.1116.0114	15W	4000K	1320 Lm	145x145mm
BHOF1.1117.0112	20W	3000K	1680 Lm	170x170mm
BHOF1.1117.0114	20W	4000K	1710 Lm	170x170mm

BAHAMAS



Puissance | 14-30W ⚡

Couleur de Température (K) | CCT Tri-Color

Lumens | 1190-2820 Lm

Dimensions | Ø143 | Ø165 | Ø200 | Ø230mm

Options | DALI ✓ | DALI/PUSH ✓

IP
44

IRC
>80

UGR
<19

L80B10
50.000h

References	Puissances	K	Lumens	Dimensions
BIDE562006	14W	CCT	1190 Lm	Ø143mm
BIDE562005	18W	CCT	1550 Lm	Ø165mm
BIDE562001	20W	CCT	1720 Lm	Ø200mm
BIDE562002	30W	CCT	2820 Lm	Ø230mm

LONDON

Puissance | 3-24W ⚡

Couleur de Température (K) | CCT Tri-Color

Lumens | 270-2160 Lm

Dimensions | Ø70mm | Ø105mm | Ø155mm
| Ø205mm | Ø225mm | Ø280mm

Options | DALI ✓ | DALI/PUSH ✓



IP
44

IRC
>80

UGR
<19

L80B10
50.000h

References	Puissances	K	Lumens	Dimensions
BIDE899013	3W	CCT	270 Lm	Ø70mm
BIDE899014	6W	CCT	540 Lm	Ø105mm
BIDE899015	12W	CCT	1080 Lm	Ø155mm
BIDE899016	18W	CCT	1620 Lm	Ø205mm
BIDE899017	20W	CCT	1800 Lm	Ø225mm
BIDE899031	24W	CCT	2160 Lm	Ø280mm

TAKEO T75



IP
54

IRC
>90

IRC
>80

UGR
<19

L80B10
50.000h

Puissance | 9-13W ⚡

Couleur de Température (K) | 2700K | 3000K | 4000K ●

Lumens | 550-1050 Lm 💡

Dimensions | Ø75mm (⊘)

Options | DALI ✓ | DALI/PUSH ✓ ⚡

IP
54

IRC
>95

IRC
>90

IRC
>80

UGR
<19

L80B10
50.000h

TAKEO T100

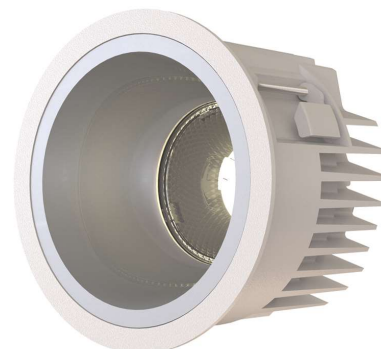

Puissance | 11-21W ⚡

Couleur de Température (K) | 2700K | 3000K | 4000K | DIM-TO-WARM | TW ●

Lumens | 800-1200 Lm 💡

Dimensions | Ø100mm (⊘)

Options | DALI ✓ | DALI/PUSH ✓ ⚡

TAKEO T150



IP
54

IRC
>90

IRC
>80

UGR
<19

L80B10
50.000h

Puissance | 21-28W ⚡

Couleur de Température (K) | 2700K | 3000K | 4000K | TW ●

Lumens | 1700-2500 Lm 💡

Dimensions | Ø150mm (⊘)

Options | DALI ✓ | DALI/PUSH ✓ ⚡

IP
54

IRC
>90

IRC
>80

UGR
<19

L80B10
50.000h

TAKEO T200



Puissance | 28-56W ⚡

Couleur de Température (K) | 2700K | 3000K | 4000K | TW ●

Lumens | 2600-5600 Lm 💡

Dimensions | Ø200mm (⊘)

Options | DALI ✓ | DALI/PUSH ✓ ⚡

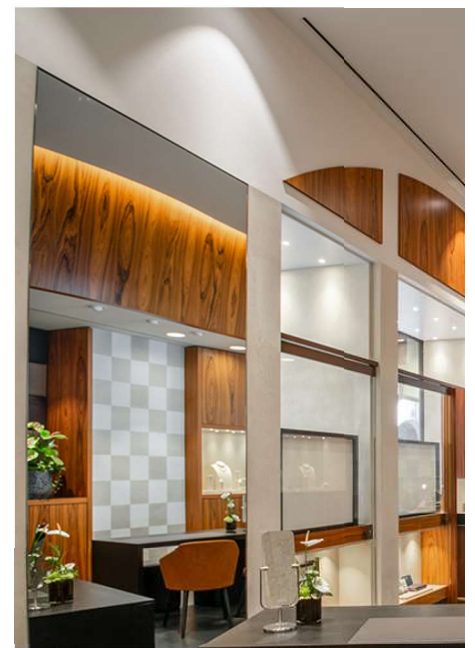
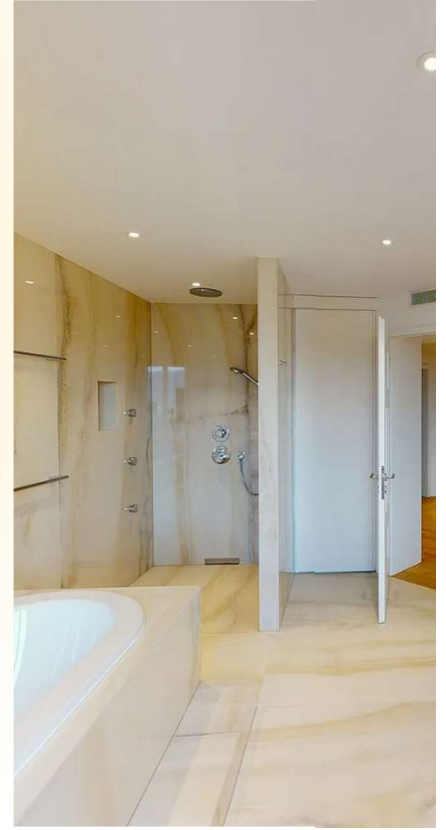

SPOT



IR

<u>Puissance</u>	5,8W ⚡
<u>Couleur de Température (K)</u>	3000K 4000K 🌞
<u>Lumens</u>	670-700 Lm 💡
<u>Dimensions</u>	Ø83mm 📏
<u>Options</u>	DALI ✓ DALI/PUSH ✓ ⚡

IP
20-54

IRC
>80

UGR
19

L70B10
60.000h

Blanc = B
Noir = N

<u>References</u>	<u>Puissances</u>	<u>K</u>	<u>Lumens</u>	<u>Dimensions</u>
BNORIR03STX	5,8W	3000K	670 Lm	Ø83mm
BNORIR04STX	5,8W	4000K	700 Lm	Ø83mm

IQ

<u>Puissance</u>	5,8W ⚡
<u>Couleur de Température (K)</u>	3000K 4000K 🌞
<u>Lumens</u>	670-700 Lm 💡
<u>Dimensions</u>	79x79mm 📏
<u>Options</u>	DALI ✓ DALI/PUSH ✓ ⚡



IP
20-54

IRC
>80





UGR
19

L70B10
60.000h

Blanc = B
Noir = N

<u>References</u>	<u>Puissances</u>	<u>K</u>	<u>Lumens</u>	<u>Dimensions</u>
BNORIQ03STX	5,8W	3000K	670 Lm	83x83mm
BNORIQ04STX	5,8W	4000K	700 Lm	83x83mm





HOLLOW MICRO LED

<u>Puissance</u>	3,5W ⚡
<u>Couleur de Température (K)</u>	2700K 3000K 4000K 
<u>Lumens</u>	170-190 Lm 
<u>Dimensions</u>	Ø41mm 
<u>Options</u>	DALI ✓ DALI/PUSH ✓ 

IRC
>90

<u>References</u>	<u>Puissances</u>	<u>K</u>	<u>Lumens</u>	<u>Dimensions</u>
BAQM927	3,5W	2700K	170 Lm	Ø41mm
BAQM930	3,5W	3000K	180 Lm	Ø41mm
BAQM940	3,5W	4000K	190 Lm	Ø41mm

HOLLOW MINI LED

<u>Puissance</u>	8,5W ⚡
<u>Couleur de Température (K)</u>	2700K 3000K 4000K 
<u>Lumens</u>	480-540 Lm 
<u>Dimensions</u>	Ø63mm 
<u>Options</u>	DALI ✓ DALI/PUSH ✓ 

IRC
>90

<u>References</u>	<u>Puissances</u>	<u>K</u>	<u>Lumens</u>	<u>Dimensions</u>
BAQM927	8,5W	2700K	480 Lm	Ø63mm
BAQM930	8,5W	3000K	510 Lm	Ø63mm
BAQM940	8,5W	4000K	540 Lm	Ø63mm

HOLLOW LED

<u>Puissance</u>	8,5W ⚡
<u>Couleur de Température (K)</u>	2700K 3000K 4000K 🌈
<u>Lumens</u>	480-540 Lm 💡
<u>Dimensions</u>	Ø78mm 📏
<u>Options</u>	DALI ✓ DALI/PUSH ✓ ⚡

IP
20-44

IRC
>90

<u>References</u>	<u>Puissances</u>	<u>K</u>	<u>Lumens</u>	<u>Dimensions</u>
BAQM927	8,5W	2700K	480 Lm	Ø78mm
BAQM930	8,5W	3000K	510 Lm	Ø78mm
BAQM940	8,5W	4000K	540 Lm	Ø78mm

HOLLOW MOVE LED

<u>Puissance</u>	8,5-11W ⚡
<u>Couleur de Température (K)</u>	2700K 3000K 4000K 🌈
<u>Lumens</u>	840-920 Lm 💡
<u>Dimensions</u>	Ø63mm Ø78mm 📏
<u>Options</u>	DALI ✓ DALI/PUSH ✓ ⚡



IRC
>90

IP
20-44

<u>References</u>	<u>Puissances</u>	<u>K</u>	<u>Lumens</u>	<u>Dimensions</u>
BAQM927	8,5W	2700K	480 Lm	Ø63mm
BAQM927	11W	2700K	840 Lm	Ø78mm
BAQM930	8,5W	3000K	510 Lm	Ø63mm
BAQM930	11W	3000K	870 Lm	Ø78mm
BAQM940	8,5W	4000K	540 Lm	Ø63mm
BAQM940	11W	4000K	920 Lm	Ø78mm

IRC
>90

<u>Puissance</u>	1,5-26,5W ⚡
<u>Couleur de Température (K)</u>	2700K 3000K 4000K 🌞
<u>Lumens</u>	100-2260 Lm 💡
<u>Dimensions</u>	50x50 80x50 150x50 280x50 410x50mm 📏
<u>Options</u>	DALI ✓ DALI/PUSH ✓ ⚡

References	Puissances	K	Lumens	Dimensions
BAQL927	1,5W	2700K	100 Lm	50x50mm
BAQL927	1,5W	2700K	140 Lm	80x50mm
BAQL927	5W	2700K	350 Lm	150x50mm
BAQL927	9,5W	2700K	700 Lm	280x50mm
BAQL927	14,5W	2700K	1050 Lm	410x50mm
BAQM927	3,5W	2700K	180 Lm	50x50mm
BAQM927	4,5W	2700K	270 Lm	80x50mm
BAQM927	9W	2700K	620 Lm	150x50mm
BAQM927	17,5W	2700K	1250 Lm	280x50mm
BAQM927	26,5W	2700K	1880 Lm	410x50mm
BAQL930	1,5W	3000K	100 Lm	50x50mm
BAQL930	1,5W	3000K	140 Lm	80x50mm
BAQL930	5W	3000K	370 Lm	150x50mm
BAQL930	9,5W	3000K	750 Lm	280x50mm
BAQL930	14,5W	3000K	1140 Lm	410x50mm
BAQM930	3,5W	3000K	180 Lm	50x50mm
BAQM930	4,5W	3000K	270 Lm	80x50mm
BAQM930	9W	3000K	670 Lm	150x50mm
BAQM930	17,5W	3000K	1350 Lm	280x50mm
BAQM930	26,5W	3000K	2020 Lm	410x50mm
BAQL940	3,5W	4000K	180 Lm	50x50mm
BAQL940	4,5W	4000K	270 Lm	80x50mm
BAQL940	9W	4000K	670 Lm	150x50mm
BAQL940	17,5W	4000K	1350 Lm	280x50mm
BAQL940	26,5W	4000K	2020 Lm	410x50mm
BAQM940	3,5W	3000K	180 Lm	50x50mm
BAQM940	4,5W	3000K	270 Lm	80x50mm
BAQM940	9W	3000K	670 Lm	150x50mm
BAQM940	17,5W	3000K	1350 Lm	280x50mm
BAQM940	26,5W	3000K	2020 Lm	410x50mm

SWING NEXT LED TRIM



<u>Puissance</u>	14W ⚡
<u>Couleur de Température (K)</u>	2700K 3000K 4000K 🌈
<u>Lumens</u>	910-1010 Lm 💡
<u>Dimensions</u>	Ø111,5mm 📏
<u>Options</u>	DALI ✓ DALI/PUSH ✓ ⚡

IRC
>90

<u>References</u>	<u>Puissances</u>	<u>K</u>	<u>Lumens</u>	<u>Dimensions</u>
BAQM927	14W	2700K	910 Lm	Ø111,5mm
BAQM930	14W	3000K	960 Lm	Ø111,5mm
BAQM940	14W	4000K	1010 Lm	Ø111,5mm

LIBERTAD



<u>Puissance</u>	6-12W ⚡
<u>Couleur de Température (K)</u>	2700K-3200K-4000K 🌈
<u>Lumens</u>	478-1140 Lm 💡
<u>Dimensions</u>	Ø81mm Ø103mm Ø140mm 📏
<u>Options</u>	DALI ✓ DALI/PUSH ✓ ⚡

IRC
>80

IP
44

UGR
<19

L70B10
35.000h

<u>References</u>	<u>Puissances</u>	<u>K</u>	<u>Lumens</u>	<u>Dimensions</u>
○ BHOF1.1130.7118	6W	2.7/3.2/4000K	478/545/537 Lm	Ø81mm
● BHOF1.1130.7218	6W	2.7/3.2/4000K	478/545/537 Lm	Ø81mm
○ BHOF1.1131.7118	9W	2.7/3.2/4000K	737/832/820 Lm	Ø103mm
● BHOF1.1131.7218	9W	2.7/3.2/4000K	737/832/820 Lm	Ø103mm
○ BHOF1.1132.7118	12W	2.7/3.2/4000K	984/1140/1092 Lm	Ø140mm
● BHOF1.1132.7218	12W	2.7/3.2/4000K	984/1140/1092 Lm	Ø140mm

LIBERTAD ADJ



<u>Puissance</u>	6-9W ⚡
<u>Couleur de Température (K)</u>	2700K 3000K 4000K 🌈
<u>Lumens</u>	530-865 Lm 💡
<u>Dimensions</u>	Ø90mm Ø105mm 📏
<u>Options</u>	DALI ✓ DALI/PUSH ✓ ⚡

L70B10
35.000h

IP
20

IRC
>80

<u>References</u>	<u>Puissances</u>	<u>K</u>	<u>Lumens</u>	<u>Dimensions</u>
○BHOF1.1150.7118	6W	2,7-3K-4000K	530-590-575 Lm	Ø90mm
●BHOF1.1150.7218	6W	2,7-3K-4000K	530-590-575 Lm	Ø90mm
○BHOF1.1151.7118	9W	2,7-3K-4000K	840-890-865 Lm	Ø105mm
●BHOF1.1151.7118	9W	2,7-3K-4000K	840-890-865 Lm	Ø105mm

OSAKA

<u>Puissance</u>	15W ⚡
<u>Couleur de Température (K)</u>	2700K-3000K 🌈
<u>Lumens</u>	605-804 Lm 💡
<u>Dimensions</u>	Ø95mm 📏
<u>Options</u>	DALI ✓ DALI/PUSH ✓ ⚡



IRC
>90

IP
20

L70B10
40.000h

<u>References</u>	<u>Puissances</u>	<u>K</u>	<u>Lumens</u>	<u>Dimensions</u>
BHOF1.1068,0111	15W	2700K	605-726 Lm	Ø95mm
BHOF1.1068,0112	15W	3000K	670-804 Lm	Ø95mm

SPOT



ANDORRA

<u>Puissance</u>	12-30W ⚡
<u>Couleur de Température (K)</u>	3000K 🌞
<u>Lumens</u>	780-1950 Lm 💡
<u>Dimensions</u>	Ø100mm Ø130mm Ø160mm 📏
<u>Options</u>	DALI ✓ DALI/PUSH ✓ ⚡

L70B10
40.000h

IP
20

IRC
>90

References	Puissances	K	Lumens	Dimensions
○ BHOF1.1070.0112	12W	3000K	780 Lm	Ø100mm
● BHOF1.1070.0212	12W	3000K	780 Lm	Ø100mm
○ BHOF1.1071.0112	20W	3000K	1300 Lm	Ø130mm
● BHOF1.1071.0212	20W	3000K	1300 Lm	Ø130mm
○ BHOF1.1072.0112	30W	3000K	1950 Lm	Ø160mm
● BHOF1.1072.0112	30W	3000K	1950 Lm	Ø160mm

ITALY 2/4/10/20

<u>Puissance</u>	2W-20W ⚡
<u>Couleur de Température (K)</u>	3000K 🌞
<u>Lumens</u>	150-1440 Lm 💡
<u>Dimensions</u>	45x45 75x45 147x45 280x45mm 📏
<u>Options</u>	DALI ✓ DALI/PUSH ✓ ⚡

ITALY 2



ITALY 4



ITALY 10



ITALY 20



IRC
>90

IP
40

L70B10
40.000h

UGR
>10

References	Puissances	K	Lumens	Dimensions
15° BHOF1.1000.0112	2W	3000K	150 Lm	45x45mm
40° BHOF1.1002.0112	2W	3000K	150 Lm	45x45mm
15° BHOF1.1010.0112	4W	3000K	300 Lm	75x45mm
40° BHOF1.1012.0112	4W	3000K	300 Lm	75x45mm
15° BHOF1.1020.0112	10W	3000K	720 Lm	147x45mm
40° BHOF1.1022.0112	10W	3000K	720 Lm	147x45mm
15° BHOF1.1030.0112	20W	3000K	1440 Lm	280x45mm
40° BHOF1.1032.0112	20W	3000K	1440 Lm	280x45mm

IRC
>90

IP
20-65

UGR
<19

<u>Puissance</u>	5-30W ⚡
<u>Couleur de Température (K)</u>	2700K 3000K 4000K 🌈
<u>Lumens</u>	450-3000 Lm 💡
<u>Dimensions</u>	Ø75 Ø84 Ø109 Ø111 Ø121 Ø160 Ø183 Ø220 Ø250mm 🌀
<u>Options</u>	DALI ✓ DALI/PUSH ✓ ⚡



IP20 = (Rien)

IP65 = (I)

Ø70mm = (R65)

Ø81,5mm = (R)

Ø84mm = (RA75)

Ø93mm = (RA)

Ø109mm = (R100)

Optic = (15) (24) (38)

Couleurs: Blanc(B), Noir(N), Blanc rouge(BR), Blanc Or(BO), Blanc prismatic(BPM), Blanc Noir(BN)

Electronique: ON/OFF(SR), TRIAC(A), 1-10V(B), DALI/PUSH(C)

<u>References</u>	<u>Puissances</u>	<u>K</u>	<u>Lumens</u>	<u>Dimensions</u>
BLYO60299XXXXX	5W	2700K	450 Lm	Ø70/83/84 93/97/109mm
BLYO60300XXXXX	5W	3000K	475 Lm	Ø70/83/84 93/97/109mm
BLYO60301XXXXX	5W	4000K	500 Lm	Ø70/83/84 93/97/109mm
BLYO60302XXXXX	10W	2700K	900 Lm	Ø93/109mm
BLYO60303XXXXX	10W	3000K	950 Lm	Ø93/109mm
BLYO60304XXXXX	10W	4000K	1000 Lm	Ø93/109mm
BLYO64299XXXX	20W	2700K	1800 Lm	Ø160mm
BLYO64300XXXX	20W	3000K	1900 Lm	Ø160mm
BLYO64301XXXX	20W	4000K	2000 Lm	Ø160mm
BLYO64302XXXX	30W	2700K	2700 Lm	Ø220mm
BLYO64303XXXX	30W	3000K	2850 Lm	Ø220mm
BLYO64304XXXX	30W	4000K	3000 Lm	Ø220mm

SPOT

IRC
>90

IP
20-65

UGR
<19

IP20 = (Rien)

IP65 = (I)

Optic = (15) (24) (38)

Couleurs: Blanc(B), Noir(N), Blanc rouge(BR), Blanc Or(BO), Blanc prismatic(BPM), Blanc Noir(BN)

Electronique: ON/OFF(SR), TRIAC(A), 1-10V(B), DALI/PUSH(C)

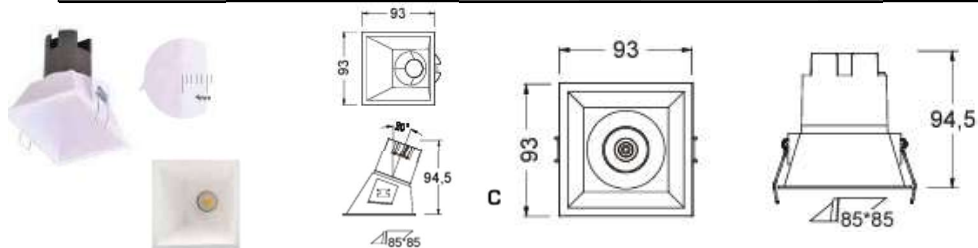

References	Puissances	K	Lumens	Dimensions
BLYO60299XXXX	5W	2700K	450 Lm	93x93mm
BLYO60300XXXX	5W	3000K	475 Lm	93x93mm
BLYO60301XXXX	5W	4000K	500 Lm	93x93mm
BLYO60302XXXX	10W	2700K	900 Lm	93x93mm
BLYO60303XXXX	10W	3000K	950 Lm	93x93mm
BLYO60304XXXX	10W	4000K	1000 Lm	93x93mm

SIRA

Puissance | 5-10W ⚡

Couleur de Température (K) | 2700K | 3000K | 4000K

Lumens | 450-1000 Lm 💡

Dimensions | 93x93mm

Options | DALI ✓ | DALI/PUSH ✓

ANNECY

Puissance | 5-8W ⚡

Couleur de Température (K) | 2700K | 3000K | 4000K | 6000K

Lumens | 500-800 Lm 💡

Dimensions | Ø90mm

Options | DALI ✓ | DALI/PUSH ✓

IP
65

L80B10
54.000h

UGR
<19

IRC
>80

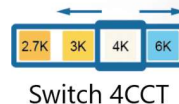

References	Puissances	K	Lumens	Dimensions
BIDE827004	5-8W	2,7/3/4/6000K	500-800 Lm	Ø90mm

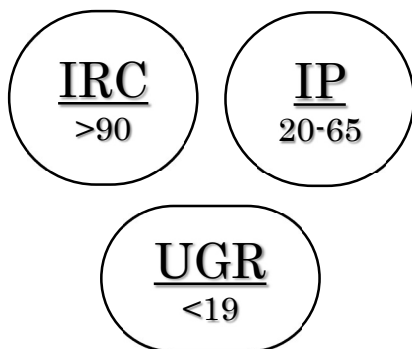

<u>Puissance</u>	5-30W ⚡
<u>Couleur de Température (K)</u>	2700K 3000K 4000K ●
<u>Lumens</u>	450-3000 Lm 💡
<u>Dimensions</u>	Ø97 Ø109 Ø111 Ø121 Ø136,7 Ø183 Ø250mm 🌀
<u>Options</u>	DALI ✓ DALI/PUSH ✓ ⚡

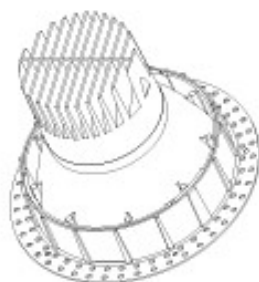

IP20 = (Rien)
IP65 = (I)

Trimless = T

Ø97mm = (R65)

Ø111mm = (R)

Ø121mm = (R)

Ø136,7mm = (R100)

Optic = (15) (24) (38)

Couleurs: Blanc(B), Noir(N), Blanc rouge(BR), Blanc Or(BO), Blanc prisme(BPM), Blanc Noir(BN)

Electronique: ON/OFF(SR), TRIAC(A), 1-10V(B), DALI/PUSH(C)

<u>References</u>	<u>Puissances</u>	<u>K</u>	<u>Lumens</u>	<u>Dimensions</u>
BLYO60299XXXXXX	5W	2700K	450 Lm	Ø97/Ø111mm
BLYO60300XXXXXX	5W	3000K	475 Lm	Ø97/Ø111mm
BLYO60301XXXXXX	5W	4000K	500 Lm	Ø97/Ø111mm
BLYO60302XXXXXX	10W	2700K	900 Lm	Ø121/136,7mm
BLYO60303XXXXXX	10W	3000K	950 Lm	Ø93/109mm
BLYO60304XXXXXX	10W	4000K	1000 Lm	Ø93/109mm
BLYO64299XXXXX	20W	2700K	1800 Lm	Ø183mm
BLYO64300XXXXX	20W	3000K	1900 Lm	Ø183mm
BLYO64301XXXXX	20W	4000K	2000 Lm	Ø183mm
BLYO64302XXXXX	30W	2700K	2700 Lm	Ø250mm
BLYO64303XXXXX	30W	3000K	2850 Lm	Ø250mm
BLYO64304XXXXX	30W	4000K	3000 Lm	Ø250mm

SPOT



Redondo = T
 Optic = (15) (25) (50)
 Couleurs: Blanc(B), Noir(N),
 Blanc Noir(BN), Noir Blanc(NB)

LISA

<u>Puissance</u>	3W ⚡
<u>Couleur de Température (K)</u>	2700K 3000K 4000K ●
<u>Lumens</u>	270-300 Lm 💡
<u>Dimensions</u>	Ø40mm
<u>Options</u>	DALI ✓ DALI/PUSH ✓

IP
20

UGR
<19

IRC
>90

References	Puissances	K	Lumens	Dimensions
BLYO60400XXX	3W	2700K	270 Lm	Ø40mm
BLYO60401XXX	3W	3000K	285 Lm	Ø40mm
BLYO60402XXX	3W	4000K	300 Lm	Ø40mm

LUNA



<u>Puissance</u>	8W ⚡
<u>Couleur de Température (K)</u>	2700K 3000K 4000K ●
<u>Lumens</u>	720 - 800 Lm 💡
<u>Dimensions</u>	Ø75mm
<u>Options</u>	DALI ✓ DALI/PUSH ✓

Optic = (35) (55)
 Couleurs: Blanc(B), Noir(N)
 Electronique: ON/OFF(SR), TRIAC(A),
 1-10V(B), DALI/PUSH(C)

IP
65

UGR
<19

IRC
>90

References	Puissances	K	Lumens	Dimensions
BLYO60560XXX	8W	2700K	720 Lm	Ø75mm
BLYO60561XXX	8W	3000K	760 Lm	Ø75mm
BLYO60562XXX	8W	4000K	800 Lm	Ø75mm

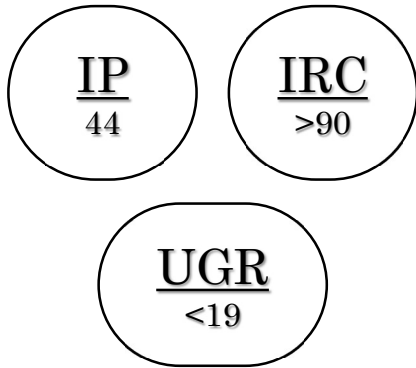

<u>Puissance</u>	20-40W ⚡
<u>Couleur de Température (K)</u>	3000K 4000K 3 CCT
<u>Lumens</u>	1560-3200 Lm 💡
<u>Dimensions</u>	Ø110 Ø115 115x115 Ø140 Ø160 Ø165 165x165 Ø190mm
<u>Options</u>	DALI ✓ DALI/PUSH ✓



Version A



Version B



Version C



Version D



Optic = (15) (24) (38)

Couleurs: Blanc(B), Blanc Or(BO), Blanc Noir(BN), Blanc Prismarine(NB)

Electronique: ON/OFF(SR), TRIAC(A), 1-10V(B), DALI/PUSH(C)

<u>References</u>	<u>Puissances</u>	<u>K</u>	<u>Lumens</u>	<u>Dimensions</u>
BLYO60370XXX	20W	3000K	1560 Lm	Ø110mm
BLYO60371XXX	20W	4000K	1600 Lm	Ø110mm
BLYO60360XXX	20W	3 CCT	1600 Lm	Ø110mm
BLYO60373XXX	40W	3000K	3120 Lm	Ø160mm
BLYO60374XXX	40W	4000K	3200 Lm	Ø160mm
BLYO60363XXX	40W	3 CCT	3200 Lm	Ø160mm
BLYO60360AXX	20W	3 CCT	1600 Lm	Ø115mm
BLYO60363AXX	40W	3 CCT	3200 Lm	Ø165mm
BLYO60360BXX	20W	3 CCT	1600 Lm	115x115mm
BLYO60363BXX	40W	3 CCT	3200 Lm	165x165mm
BLYO60360CXX	20W	3 CCT	1600 Lm	Ø140mm
BLYO60363CXX	40W	3 CCT	3200 Lm	Ø190mm
BLYO60360DXX	20W	3 CCT	1600 Lm	Ø115mm
BLYO60363DXX	40W	3 CCT	3200 Lm	Ø165mm

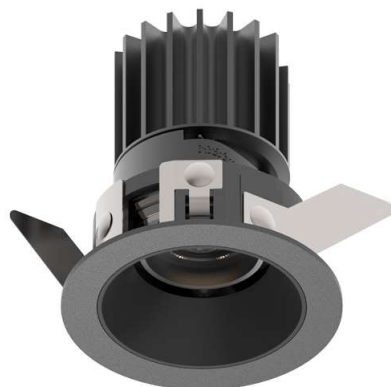

SENSE 45

<u>Puissance</u>	6W ⚡
<u>Couleur de Température (K)</u>	2700K 3000K 4000K
<u>Lumens</u>	330-380 Lm
<u>Dimensions</u>	Ø55mm
<u>Options</u>	DALI ✓ DALI/PUSH ✓

L80B10
50.000h

IP
20

UGR
<19

IRC
90

SENSE 45 SQUARE

<u>Puissance</u>	6W ⚡
<u>Couleur de Température (K)</u>	2700K 3000K 4000K
<u>Lumens</u>	330-380 Lm
<u>Dimensions</u>	55x55mm
<u>Options</u>	DALI ✓ DALI/PUSH ✓

L80B10
50.000h

IP
20

UGR
<19

IRC
90



SENSE 68

<u>Puissance</u>	9-13W ⚡
<u>Couleur de Température (K)</u>	2700K 3000K 4000K DIM TO WARM
<u>Lumens</u>	320-850 Lm
<u>Dimensions</u>	Ø67mm Ø78mm
<u>Options</u>	DALI ✓ DALI/PUSH ✓

L80B10
50.000h

IP
20

UGR
<19

IRC
90

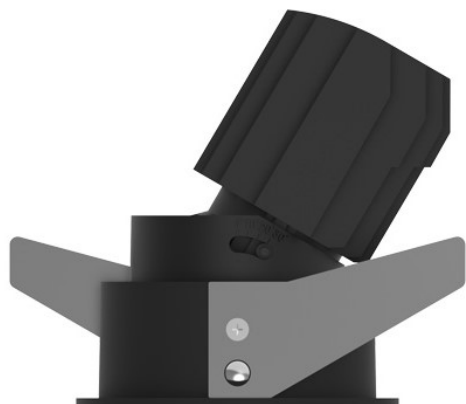



SENSE 125

<u>Puissance</u>	21W ⚡
<u>Couleur de Température (K)</u>	2700K 3000K 4000K
<u>Lumens</u>	700-1400 Lm
<u>Dimensions</u>	Ø125mm Ø137mm
<u>Options</u>	DALI ✓ DALI/PUSH ✓

<u>L80B10</u> 50.000h	<u>IP</u> 20	<u>UGR</u> <19	<u>IRC</u> 90
--------------------------	-----------------	-------------------	------------------

SENSE 125 SQUARE

<u>Puissance</u>	21W ⚡
<u>Couleur de Température (K)</u>	2700K 3000K 4000K
<u>Lumens</u>	700-1400 Lm
<u>Dimensions</u>	122x122mm 134x134mm
<u>Options</u>	DALI ✓ DALI/PUSH ✓



<u>L80B10</u> 50.000h	<u>IP</u> 20	<u>UGR</u> <19	<u>IRC</u> 90
--------------------------	-----------------	-------------------	------------------

SENSE 150



<u>Puissance</u>	28W ⚡
<u>Couleur de Température (K)</u>	2700K 3000K 4000K
<u>Lumens</u>	900-2000 Lm
<u>Dimensions</u>	Ø150mm Ø162mm
<u>Options</u>	DALI ✓ DALI/PUSH ✓

<u>L80B10</u> 50.000h	<u>IP</u> 20	<u>UGR</u> <19	<u>IRC</u> 90
--------------------------	-----------------	-------------------	------------------



SENSE 150 SQUARE

<u>Puissance</u>	28W ⚡
<u>Couleur de Température (K)</u>	2700K 3000K 4000K
<u>Lumens</u>	900-2000 Lm
<u>Dimensions</u>	145x145mm 159x159mm
<u>Options</u>	DALI ✓ DALI/PUSH ✓

L80B10
50.000h

IP
20

UGR
<19

IRC
90

SENSE 45 DOUBLE

<u>Puissance</u>	26W ⚡
<u>Couleur de Température (K)</u>	2700K 3000K 4000K
<u>Lumens</u>	660-760 Lm
<u>Dimensions</u>	98x55mm
<u>Options</u>	DALI ✓ DALI/PUSH ✓



L80B10
50.000h

IP
20

UGR
<19

IRC
90

SENSE 45 TRIPLE

<u>Puissance</u>	36W ⚡
<u>Couleur de Température (K)</u>	2700K 3000K 4000K
<u>Lumens</u>	990-1140 Lm
<u>Dimensions</u>	137x55mm
<u>Options</u>	DALI ✓ DALI/PUSH ✓



L80B10
50.000h

IP
20

UGR
<19

IRC
90

SENSE 45 QUADRUPLE

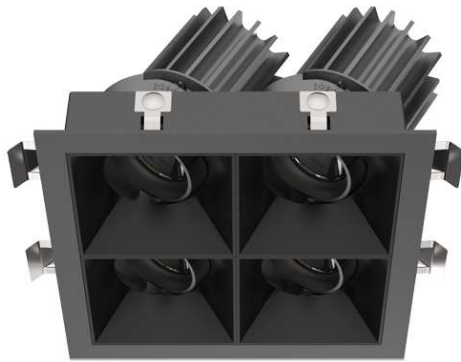

Puissance | 46W ⚡

Couleur de Température (K) | 2700K | 3000K | 4000K

Lumens | 1320-1520 Lm 💡

Dimensions | 98x98mm

Options | DALI ✓ | DALI/PUSH ✓ ⇌

L80B10
50.000h

IP
20

UGR
<19

IRC
90

SENSE 68 DOUBLE

Puissance | 21,3-29W ⚡

Couleur de Température (K) | 2700K | 3000K | 4000K | DIM TO WARM

Lumens | 640-1700 Lm 💡

Dimensions | 176x112 | 142x78 | 133x68mm

Options | DALI ✓ | DALI/PUSH ✓ ⇌



L80B10
50.000h

IP
20

UGR
<19

IRC
90

SENSE 68 TRIPLE

Puissance | 31,2-37,5W ⚡

Couleur de Température (K) | 2700K | 3000K | 4000K | DIM TO WARM

Lumens | 960-2550 Lm 💡

Dimensions | 197x68 | 207x78 | 240x112mm

Options | DALI ✓ | DALI/PUSH ✓ ⇌



L80B10
50.000h

IP
20

UGR
<19

IRC
90

SENSE 68 QUADRUPLE



<u>Puissance</u>	41,4-47,5W ⚡
<u>Couleur de Température (K)</u>	2700K 3000K 4000K DIM TO WARM
<u>Lumens</u>	1280-3400 Lm 💡
<u>Dimensions</u>	133x133 142x142 176x176mm
<u>Options</u>	DALI ✓ DALI/PUSH ✓ ⚡

<u>L80B10</u> 50.000h	<u>IP</u> 20	<u>UGR</u> <19	<u>IRC</u> 90
--------------------------	-----------------	-------------------	------------------

CLUB M3

<u>Puissance</u>	9-14W ⚡
<u>Couleur de Température (K)</u>	2700K 3000K 4000K DIM TO WARM
<u>Lumens</u>	650-1150 Lm 💡
<u>Dimensions</u>	Ø50mm
<u>Options</u>	DALI ✓ DALI/PUSH ✓ ⚡



<u>L80B10</u> 50.000h	<u>IP</u> 54	<u>UGR</u> <19	<u>IRC</u> 80	<u>IRC</u> 90	<u>IRC</u> 95
--------------------------	-----------------	-------------------	------------------	------------------	------------------

CLUB M4



<u>Puissance</u>	11-15W ⚡
<u>Couleur de Température (K)</u>	2700K 3000K 4000K DIM TO WARM
<u>Lumens</u>	800-1400 Lm 💡
<u>Dimensions</u>	Ø50mm
<u>Options</u>	DALI ✓ DALI/PUSH ✓ ⚡

<u>L80B10</u> 50.000h	<u>IP</u> 54	<u>UGR</u> <19	<u>IRC</u> 80	<u>IRC</u> 90	<u>IRC</u> 95
--------------------------	-----------------	-------------------	------------------	------------------	------------------



CLUB M4 PRO

<u>Puissance</u>	9-21W ⚡
<u>Couleur de Température (K)</u>	2700K 3000K 4000K DIM TO WARM TW
<u>Lumens</u>	≤ 1700Lm 💡
<u>Dimensions</u>	Ø50mm 📏
<u>Options</u>	DALI ✓ DALI/PUSH ✓ ⚡

L80B10
50.000h

IP
54

UGR
<19

IRC
90

IRC
95

IRC
97

CLUB TRF1

<u>Puissance</u>	9-21W ⚡
<u>Couleur de Température (K)</u>	2700K 3000K 4000K DIM TO WARM
<u>Lumens</u>	≤ 1600Lm 💡
<u>Dimensions</u>	Ø85mm 📏
<u>Options</u>	DALI ✓ DALI/PUSH ✓ ⚡



L80B10
50.000h

IP
20

IP
54

UGR
<19

IRC
80

IRC
90

CLUB KRF1-EI



<u>Puissance</u>	9-21W ⚡
<u>Couleur de Température (K)</u>	2700K 3000K 4000K DIM TO WARM
<u>Lumens</u>	≤ 1600Lm 💡
<u>Dimensions</u>	Ø71mm 📏
<u>Options</u>	DALI ✓ DALI/PUSH ✓ ⚡

L80B10
50.000h

IP
20

IP
44

UGR
<19

IRC
80

IRC
90

CLUB KRF1



<u>Puissance</u>	9-21W ⚡
<u>Couleur de Température (K)</u>	2700K 3000K 4000K DIM TO WARM TW
<u>Lumens</u>	≤ 1600Lm 💡
<u>Dimensions</u>	Ø71mm 📏
<u>Options</u>	DALI ✓ DALI/PUSH ✓ ⚡

L80B10
50.000h

IP
20

IP
44

UGR
<19

IRC
80

IRC
90

CLUB TA5

<u>Puissance</u>	9-15W ⚡
<u>Couleur de Température (K)</u>	2700K 3000K 4000K DIM TO WARM
<u>Lumens</u>	≤ 1250Lm 💡
<u>Dimensions</u>	Ø85 Ø90mm 📏
<u>Options</u>	DALI ✓ DALI/PUSH ✓ ⚡



L80B10
50.000h

IP
20

IP
65

UGR
<19

IRC
80

IRC
90

IRC
95

CLUB KA5



<u>Puissance</u>	9-15W ⚡
<u>Couleur de Température (K)</u>	2700K 3000K 4000K DIM TO WARM
<u>Lumens</u>	≤ 1250Lm 💡
<u>Dimensions</u>	Ø71mm 📏
<u>Options</u>	DALI ✓ DALI/PUSH ✓ ⚡

L80B10
50.000h

IP
20

UGR
<19

IRC
80

IRC
90

IRC
95

CLUB TA6



<u>Puissance</u>	9-15W ⚡
<u>Couleur de Température (K)</u>	2700K 3000K 4000K DIM TO WARM TW
<u>Lumens</u>	≤ 1050Lm 💡
<u>Dimensions</u>	Ø85mm 📏
<u>Options</u>	DALI ✓ DALI/PUSH ✓ ⚡

L80B10
50.000h

IP
20

UGR
<19

IRC
80

IRC
90

IRC
95

CLUB KA6

<u>Puissance</u>	9-15W ⚡
<u>Couleur de Température (K)</u>	2700K 3000K 4000K DIM TO WARM
<u>Lumens</u>	≤ 1050Lm 💡
<u>Dimensions</u>	Ø71mm 📏
<u>Options</u>	DALI ✓ DALI/PUSH ✓ ⚡



L80B10
50.000h

IP
20

UGR
<19

IRC
80

IRC
90

IRC
95

CLUB TA7



<u>Puissance</u>	9-15W ⚡
<u>Couleur de Température (K)</u>	2700K 3000K 4000K DIM TO WARM
<u>Lumens</u>	≤ 850Lm 💡
<u>Dimensions</u>	Ø85mm 📏
<u>Options</u>	DALI ✓ DALI/PUSH ✓ ⚡

L80B10
50.000h

IP
20

UGR
<19

IRC
80

IRC
90

IRC
95

CLUB KA7

<u>Puissance</u>	9-15W ⚡
<u>Couleur de Température (K)</u>	2700K 3000K 4000K DIM TO WARM TW
<u>Lumens</u>	≤ 850Lm 💡
<u>Dimensions</u>	Ø71mm
<u>Options</u>	DALI ✓ DALI/PUSH ✓ ⇌

L80B10
50.000h

IP
20

UGR
<19

IRC
80

IRC
90

IRC
95

CLUB TA8

<u>Puissance</u>	9-15W ⚡
<u>Couleur de Température (K)</u>	2700K 3000K 4000K DIM TO WARM
<u>Lumens</u>	≤ 1150Lm 💡
<u>Dimensions</u>	Ø85mm
<u>Options</u>	DALI ✓ DALI/PUSH ✓ ⇌



L80B10
50.000h

IP
20

UGR
<19

IRC
80

IRC
90

IRC
95

CLUB KA8

<u>Puissance</u>	9-15W ⚡
<u>Couleur de Température (K)</u>	2700K 3000K 4000K DIM TO WARM
<u>Lumens</u>	≤ 1150Lm 💡
<u>Dimensions</u>	Ø71mm
<u>Options</u>	DALI ✓ DALI/PUSH ✓ ⇌

L80B10
50.000h

IP
20

UGR
<19

IRC
80

IRC
90

IRC
95

CLUB TA9



<u>Puissance</u>	9-15W ⚡
<u>Couleur de Température (K)</u>	2700K 3000K 4000K DIM TO WARM
<u>Lumens</u>	≤ 1000Lm 💡
<u>Dimensions</u>	Ø85mm 📏
<u>Options</u>	DALI ✓ DALI/PUSH ✓ ⚡

L80B10
50.000h

IP
20

UGR
<19

IRC
80

IRC
90

IRC
95

CLUB KA9

<u>Puissance</u>	9-15W ⚡
<u>Couleur de Température (K)</u>	2700K 3000K 4000K DIM TO WARM
<u>Lumens</u>	≤ 1000Lm 💡
<u>Dimensions</u>	Ø71mm 📏
<u>Options</u>	DALI ✓ DALI/PUSH ✓ ⚡



L80B10
50.000h

IP
20

UGR
<19

IRC
80

IRC
90

IRC
95

CLUB TSA1

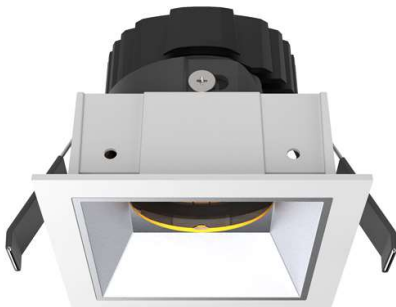

<u>Puissance</u>	9-15W ⚡
<u>Couleur de Température (K)</u>	2700K 3000K 4000K DIM TO WARM
<u>Lumens</u>	≤ 1200Lm 💡
<u>Dimensions</u>	85x85mm 📏
<u>Options</u>	DALI ✓ DALI/PUSH ✓ ⚡

L80B10
50.000h

IP
20

UGR
<19

IRC
80

IRC
90

IRC
95

CLUB KSA1

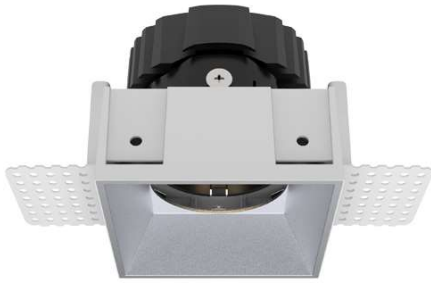

<u>Puissance</u>	9-15W ⚡
<u>Couleur de Température (K)</u>	2700K 3000K 4000K DIM TO WARM
<u>Lumens</u>	≤ 1200Lm 💡
<u>Dimensions</u>	71x71mm 📏
<u>Options</u>	DALI ✓ DALI/PUSH ✓ ⇌

L80B10
50.000h

IP
20

UGR
<19

IRC
80

IRC
90

IRC
95

CLUB TSA2



<u>Puissance</u>	9-15W ⚡
<u>Couleur de Température (K)</u>	2700K 3000K 4000K DIM TO WARM
<u>Lumens</u>	≤ 980Lm 💡
<u>Dimensions</u>	85x85mm
<u>Options</u>	DALI ✓ DALI/PUSH ✓ ⇌

L80B10
50.000h

IP
20

UGR
<19

IRC
80

IRC
90

IRC
95

CLUB KSA2



<u>Puissance</u>	9-15W ⚡
<u>Couleur de Température (K)</u>	2700K 3000K 4000K DIM TO WARM
<u>Lumens</u>	≤ 1200Lm 💡
<u>Dimensions</u>	71x71mm 📏
<u>Options</u>	DALI ✓ DALI/PUSH ✓ ⇌

L80B10
50.000h

IP
20

UGR
<19

IRC
80

IRC
90

IRC
95

CLUB TSA3



<u>Puissance</u>	9-15W ⚡
<u>Couleur de Température (K)</u>	2700K 3000K 4000K DIM TO WARM
<u>Lumens</u>	≤ 1040Lm 💡
<u>Dimensions</u>	85x85mm
<u>Options</u>	DALI ✓ DALI/PUSH ✓ ⇌

L80B10
50.000h

IP
20

UGR
<19

IRC
80

IRC
90

IRC
95

CLUB KSA3

<u>Puissance</u>	9-15W ⚡
<u>Couleur de Température (K)</u>	2700K 3000K 4000K DIM TO WARM
<u>Lumens</u>	≤ 1040Lm 💡
<u>Dimensions</u>	75x75mm
<u>Options</u>	DALI ✓ DALI/PUSH ✓ ⇌



L80B10
50.000h

IP
20

UGR
<19

IRC
80

IRC
90

IRC
95

TSA1D

KSA1D

CLUB TSA1D-KSA1D

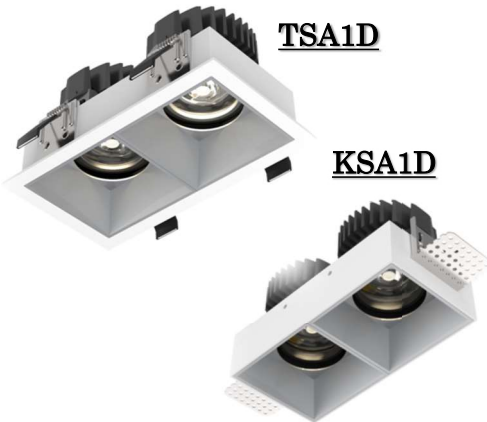

<u>Puissance</u>	18-30W ⚡
<u>Couleur de Température (K)</u>	2700K 3000K 4000K DIM TO WARM
<u>Lumens</u>	≤ 2400 Lm 💡
<u>Dimensions</u>	155x85mm 140x71,5mm
<u>Options</u>	DALI ✓ DALI/PUSH ✓ ⇌

L80B10
50.000h

IP
20

UGR
<19

IRC
80

IRC
90

IRC
95

VISION FIXED 68



<u>Puissance</u>	15-21W ⚡
<u>Couleur de Température (K)</u>	2700K 3000K 4000K 🌈
<u>Lumens</u>	≤ 1700Lm 💡
<u>Dimensions</u>	Ø77mm 📏
<u>Options</u>	DALI ✓ DALI/PUSH ✓ ⚡

L80B10
50.000h

IP
20

UGR
<19

IRC
90

VISION WALL WASHER 68

<u>Puissance</u>	15-21W ⚡
<u>Couleur de Température (K)</u>	2700K 3000K 4000K 🌈
<u>Lumens</u>	≤ 1200Lm 💡
<u>Dimensions</u>	Ø77mm 📏
<u>Options</u>	DALI ✓ DALI/PUSH ✓ ⚡



L80B10
50.000h

IP
20

IRC
90

MINUX 38



<u>Puissance</u>	8W ⚡
<u>Couleur de Température (K)</u>	2700K 3000K 4000K 🌈
<u>Lumens</u>	≤ 500 Lm 💡
<u>Dimensions</u>	Ø45mm Ø37mm 📏
<u>Options</u>	DALI ✓ DALI/PUSH ✓ ⚡

L80B10
50.000h

IP
54

UGR
<19

IRC
90

MINUX 44

<u>Puissance</u>	11W ⚡
<u>Couleur de Température (K)</u>	2700K 3000K 4000K
<u>Lumens</u>	≤ 900Lm
<u>Dimensions</u>	Ø51mm Ø43mm
<u>Options</u>	DALI ✓ DALI/PUSH ✓

L80B10
50.000h

IP
20

UGR
<19

IRC
90

MINUX 57

<u>Puissance</u>	15W ⚡
<u>Couleur de Température (K)</u>	2700K 3000K 4000K
<u>Lumens</u>	≤ 1050Lm
<u>Dimensions</u>	Ø64mm Ø57mm
<u>Options</u>	DALI ✓ DALI/PUSH ✓



L80B10
50.000h

IP
20

IRC
90

KENZO K1X30

<u>Puissance</u>	6W ⚡
<u>Couleur de Température (K)</u>	2700K 3000K 4000K
<u>Lumens</u>	≤ 400 Lm
<u>Dimensions</u>	Ø54mm
<u>Options</u>	DALI ✓ DALI/PUSH ✓

L80B10
50.000h

IP
20

UGR
<19

IRC
80

IRC
90

KENZO K1X55



<u>Puissance</u>	11W ⚡
<u>Couleur de Température (K)</u>	2700K 3000K 4000K
<u>Lumens</u>	≤ 850Lm
<u>Dimensions</u>	Ø88mm
<u>Options</u>	DALI ✓ DALI/PUSH ✓

L80B10
50.000h
IP
20
UGR
<19
IRC
80
IRC
90

KENZO K1X70



<u>Puissance</u>	15-21W ⚡
<u>Couleur de Température (K)</u>	2700K 3000K 4000K
<u>Lumens</u>	≤ 1900Lm
<u>Dimensions</u>	Ø110mm
<u>Options</u>	DALI ✓ DALI/PUSH ✓

L80B10
50.000h
IP
20
UGR
<19
IRC
80
IRC
90

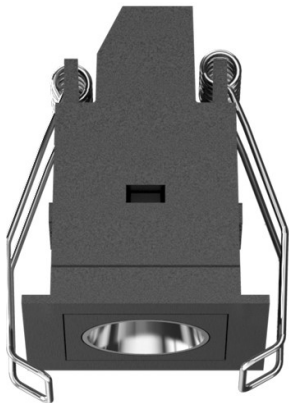

FUSION FF1

<u>Puissance</u>	3W ⚡
<u>Couleur de Température (K)</u>	2700K 3000K 4000K
<u>Lumens</u>	130-190 Lm
<u>Dimensions</u>	45x45mm
<u>Options</u>	DALI ✓ DALI/PUSH ✓

L80B10
50.000h
IP
20
UGR
<10
IRC
80
IRC
90

FUSION FF2

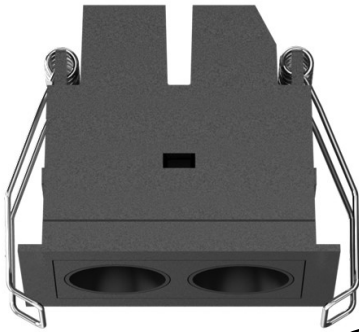

<u>Puissance</u>	6W ⚡
<u>Couleur de Température (K)</u>	2700K 3000K 4000K 🌈
<u>Lumens</u>	290-440Lm 💡
<u>Dimensions</u>	70x45mm 📏
<u>Options</u>	DALI ✓ DALI/PUSH ✓ ⚡

L80B10
50.000h
IP
20
UGR
<10
IRC
80
IRC
90

FUSION FF2 IP 65

<u>Puissance</u>	6W ⚡
<u>Couleur de Température (K)</u>	2700K 3000K 4000K 🌈
<u>Lumens</u>	≤ 280Lm 💡
<u>Dimensions</u>	75x50mm 📏
<u>Options</u>	DALI ✓ DALI/PUSH ✓ ⚡

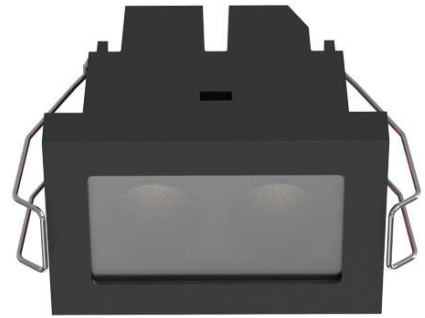

L80B10
50.000h
IP
65
UGR
<10
IRC
80
IRC
90

FUSION FF3

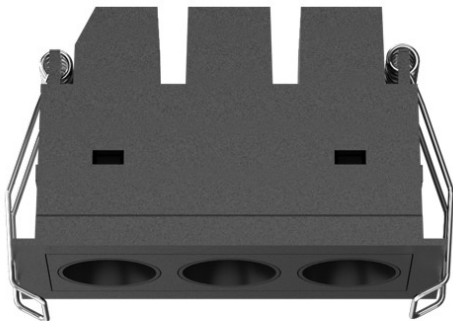

<u>Puissance</u>	9W ⚡
<u>Couleur de Température (K)</u>	2700K 3000K 4000K 🌈
<u>Lumens</u>	420-650 Lm 💡
<u>Dimensions</u>	98x45mm 📏
<u>Options</u>	DALI ✓ DALI/PUSH ✓ ⚡

L80B10
50.000h
IP
20
UGR
<10
IRC
80
IRC
90

FUSION FF3 IP65

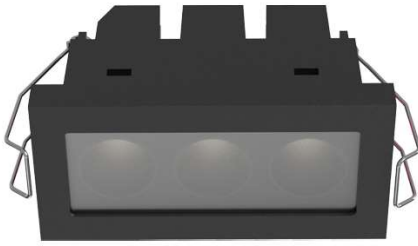

<u>Puissance</u>	9W ⚡
<u>Couleur de Température (K)</u>	2700K 3000K 4000K 🌈
<u>Lumens</u>	≤ 460Lm 💡
<u>Dimensions</u>	102x50mm 📏
<u>Options</u>	DALI ✓ DALI/PUSH ✓ ⚡

L80B10
50.000h

IP
65

UGR
<10

IRC
80

IRC
90

FUSION FF5

<u>Puissance</u>	13W ⚡
<u>Couleur de Température (K)</u>	2700K 3000K 4000K 🌈
<u>Lumens</u>	650-1100Lm 💡
<u>Dimensions</u>	152,5x45mm 150x44mm 📏
<u>Options</u>	DALI ✓ DALI/PUSH ✓ ⚡

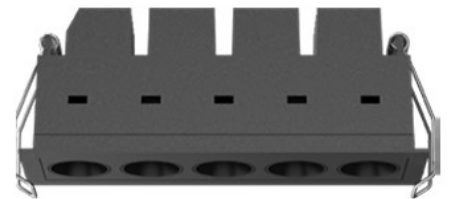

L80B10
50.000h

IP
20

UGR
<10

IRC
80

IRC
90

FUSION FF5 IP65

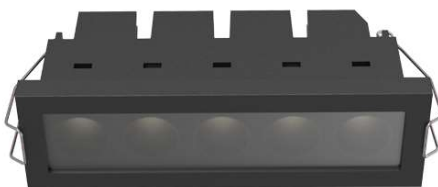

<u>Puissance</u>	13W ⚡
<u>Couleur de Température (K)</u>	2700K 3000K 4000K 🌈
<u>Lumens</u>	≤ 750Lm 💡
<u>Dimensions</u>	157x50mm 📏
<u>Options</u>	DALI ✓ DALI/PUSH ✓ ⚡

L80B10
50.000h

IP
65

UGR
<10

IRC
80

IRC
90

FUSION FF10

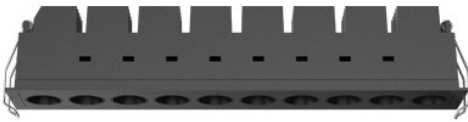

<u>Puissance</u>	24W ⚡
<u>Couleur de Température (K)</u>	2700K 3000K 4000K 🌈
<u>Lumens</u>	1400-2300Lm 💡
<u>Dimensions</u>	290x45mm 286,5x41mm 📏
<u>Options</u>	DALI ✓ DALI/PUSH ✓ ⚡

L80B10
50.000h
IP
20
UGR
<10
IRC
80
IRC
90

FUSION FF10 IP65

<u>Puissance</u>	24W ⚡
<u>Couleur de Température (K)</u>	2700K 3000K 4000K 🌈
<u>Lumens</u>	≤ 1500Lm 💡
<u>Dimensions</u>	295x50mm 📏
<u>Options</u>	DALI ✓ DALI/PUSH ✓ ⚡

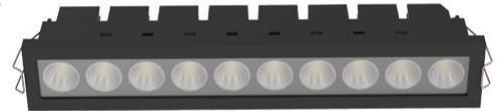

L80B10
50.000h
IP
65
UGR
<10
IRC
80
IRC
90

FUSION FX4



<u>Puissance</u>	11W ⚡
<u>Couleur de Température (K)</u>	2700K 3000K 4000K 🌈
<u>Lumens</u>	550-750Lm 💡
<u>Dimensions</u>	75x75mm 📏
<u>Options</u>	DALI ✓ DALI/PUSH ✓ ⚡

L80B10
50.000h
IP
20
UGR
<19
IRC
80
IRC
90

FUSION FA5



<u>Puissance</u>	13W ⚡
<u>Couleur de Température (K)</u>	2700K 3000K 4000K 🌈
<u>Lumens</u>	700-950Lm 💡
<u>Dimensions</u>	171x70mm 📏
<u>Options</u>	DALI ✓ DALI/PUSH ✓ ⚡

L80B10
50.000h
IP
20
UGR
<10
IRC
80
IRC
90

FUSION FA10

<u>Puissance</u>	24W ⚡
<u>Couleur de Température (K)</u>	2700K 3000K 4000K 🌈
<u>Lumens</u>	1400-2000Lm 💡
<u>Dimensions</u>	309x70mm 📏
<u>Options</u>	DALI ✓ DALI/PUSH ✓ ⚡



L80B10
50.000h
IP
65
UGR
<10
IRC
80
IRC
90

FUSION FG5

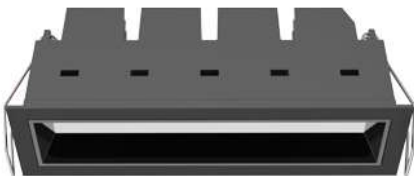

<u>Puissance</u>	13W ⚡
<u>Couleur de Température (K)</u>	2700K 3000K 4000K 🌈
<u>Lumens</u>	330-450Lm 💡
<u>Dimensions</u>	152,5x45mm 150x41mm 📏
<u>Options</u>	DALI ✓ DALI/PUSH ✓ ⚡

L80B10
50.000h
IP
20
IRC
80
IRC
90

FUSION FG10



<u>Puissance</u>	24W ⚡
<u>Couleur de Température (K)</u>	2700K 3000K 4000K
<u>Lumens</u>	750-1000Lm
<u>Dimensions</u>	290x45mm 286,5x41mm
<u>Options</u>	DALI ✓ DALI/PUSH ✓

L80B10
50.000h
IP
20
UGR
<10
IRC
80
IRC
90

FUSION FW5

<u>Puissance</u>	13W ⚡
<u>Couleur de Température (K)</u>	2700K 3000K 4000K
<u>Lumens</u>	450-650Lm
<u>Dimensions</u>	152,5x45mm 150x41mm
<u>Options</u>	DALI ✓ DALI/PUSH ✓

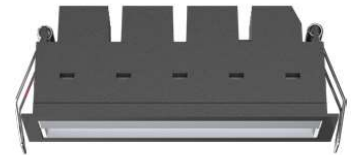

L80B10
50.000h
IP
65
IRC
80
IRC
90

FUSION FW10



<u>Puissance</u>	24W ⚡
<u>Couleur de Température (K)</u>	2700K 3000K 4000K
<u>Lumens</u>	1000-1300Lm
<u>Dimensions</u>	290x45mm 286,5x41mm
<u>Options</u>	DALI ✓ DALI/PUSH ✓

L80B10
50.000h
IP
20
IRC
80
IRC
90

FUSION FS1



<u>Puissance</u>	3W ⚡
<u>Couleur de Température (K)</u>	2700K 3000K 4000K 🌈
<u>Lumens</u>	130-190Lm 💡
<u>Dimensions</u>	70x45mm 📏
<u>Options</u>	DALI ✓ DALI/PUSH ✓ ⚡

L80B10
50.000h

IP
20

UGR
<19

IRC
80

IRC
90

FUSION FS2

<u>Puissance</u>	6W ⚡
<u>Couleur de Température (K)</u>	2700K 3000K 4000K 🌈
<u>Lumens</u>	280-380Lm 💡
<u>Dimensions</u>	98x45mm 📏
<u>Options</u>	DALI ✓ DALI/PUSH ✓ ⚡

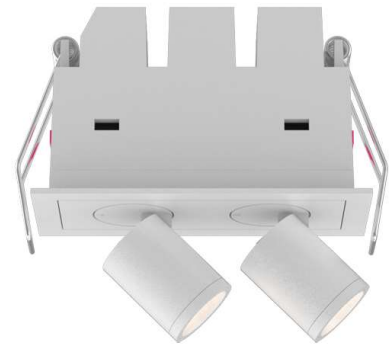

L80B10
50.000h

IP
20

UGR
<19

IRC
80

IRC
90

FUSION FS3

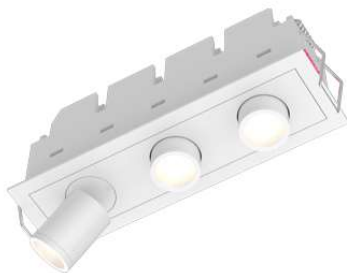

<u>Puissance</u>	9W ⚡
<u>Couleur de Température (K)</u>	2700K 3000K 4000K 🌈
<u>Lumens</u>	420-600Lm 💡
<u>Dimensions</u>	152,5x45mm 150x41mm 📏
<u>Options</u>	DALI ✓ DALI/PUSH ✓ ⚡

L80B10
50.000h

IP
20

IRC
80

IRC
90

FUSION FS6

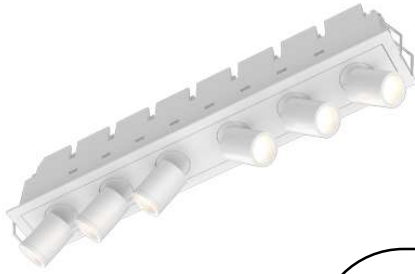

<u>Puissance</u>	15W ⚡
<u>Couleur de Température (K)</u>	2700K 3000K 4000K 🌈
<u>Lumens</u>	800-1100Lm 💡
<u>Dimensions</u>	290x45mm 288x41mm 📏
<u>Options</u>	DALI ✓ DALI/PUSH ✓ ⚡

L80B10
50.000h
IP
20
UGR
<19
IRC
80
IRC
90

FUSION FF3-FS1

<u>Puissance</u>	11W ⚡
<u>Couleur de Température (K)</u>	2700K 3000K 4000K 🌈
<u>Lumens</u>	500-700Lm 💡
<u>Dimensions</u>	152,5x45mm 150x41mm 📏
<u>Options</u>	DALI ✓ DALI/PUSH ✓ ⚡



L80B10
50.000h
IP
20
UGR
<19
IRC
80
IRC
90

FUSION FF6-FS2



<u>Puissance</u>	19W ⚡
<u>Couleur de Température (K)</u>	2700K 3000K 4000K 🌈
<u>Lumens</u>	1050-1400Lm 💡
<u>Dimensions</u>	290x45mm 288x41mm 📏
<u>Options</u>	DALI ✓ DALI/PUSH ✓ ⚡

L80B10
50.000h
IP
20
UGR
<19
IRC
80
IRC
90

SPOT MINI NAOS

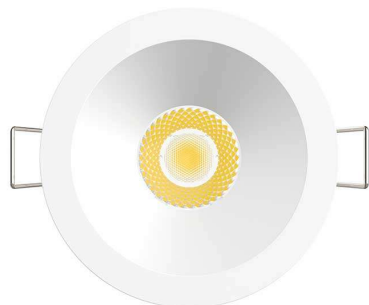

<u>Puissance</u>	5W ⚡
<u>Couleur de Température (K)</u>	2700K 3000K 4000K 🌈
<u>Lumens</u>	400Lm 💡
<u>Dimensions</u>	Ø40mm 📏
<u>Options</u>	DALI ✓ DALI/PUSH ✓ ⚙️

L70B50
30.000h

IP
20

IP
65

IRC
80

SPOT NAOS

<u>Puissance</u>	10W ⚡
<u>Couleur de Température (K)</u>	2700K 3000K 4000K 🌈
<u>Lumens</u>	800Lm 💡
<u>Dimensions</u>	Ø80mm 📏
<u>Options</u>	DALI ✓ DALI/PUSH ✓ ⚙️

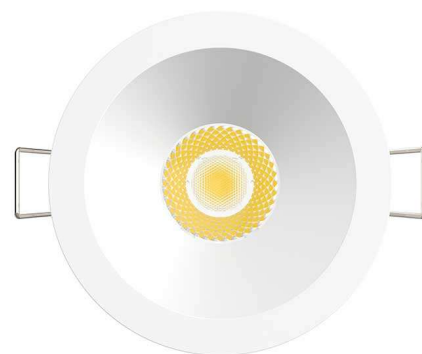

L70B50
30.000h

IP
20

IP
65

IRC
80

<u>References</u>	<u>Puissances</u>	<u>K</u>	<u>Lumens</u>	<u>Dimensions</u>
BLAE999853	5W	CCT	400 Lm	Ø50mm
BLAE999860	10W	CCT	800 Lm	Ø80mm

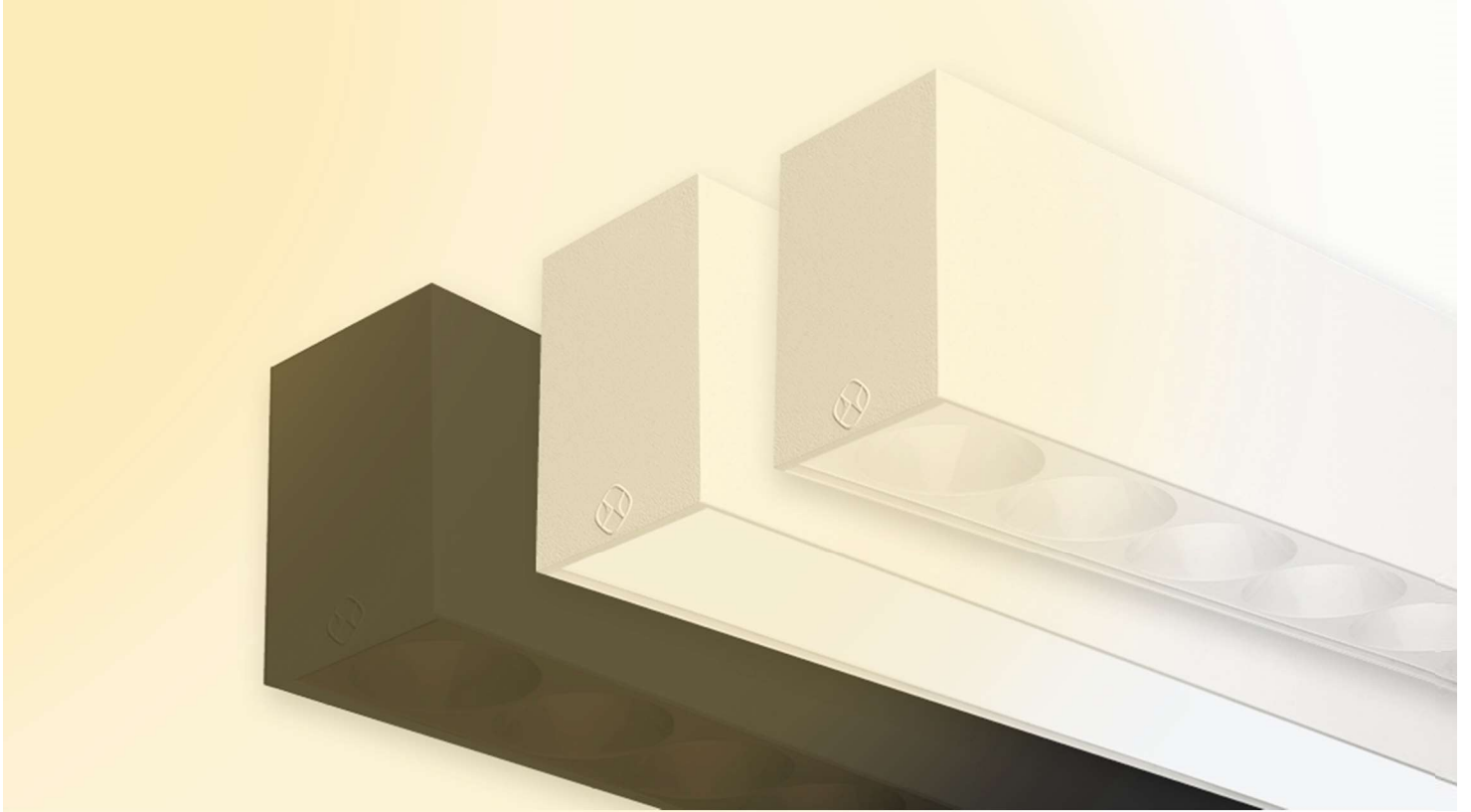

PROFIL

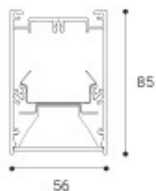

Blanc = B
Noir = N

Puissance

| 25,9-57W ⚡

Couleur de Température (K) | 2,7-5,6K | 2,7-6,5K | 3000K | 4000K

Lumens

| 3345-9000Lm 💡

Dimensions

| 56x85xLmm 📏

Options

| DALI ✓ | DALI/PUSH ✓ ⚙️

L70B10
50.000h

UGR
16

IP
30

IRC
>80

References	Puissances	K	Lumens	Dimensions (L)
BNORTX4L3RX	26,8W	3000K	3720 Lm	1126mm
BNORTX4L4RX	26,8W	4000K	4000 Lm	1126mm
BNORTX4H3RX	38W	3000K	5600 Lm	1126mm
BNORTX4H4RX	38W	4000K	6000 Lm	1126mm
BNORTX6L3RX	40,2W	3000K	5580 Lm	1688mm
BNORTX6L4RX	40,2W	4000K	6000 Lm	1688mm
BNORTX6H3RX	57W	3000K	8400 Lm	1688mm
BNORTX6H4RX	57W	4000K	9000 Lm	1688mm

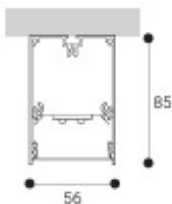

L70B10
50.000h

UGR
16

IP
30

IRC
>80

References	Puissances	K	Lumens	Dimensions (L)
BNORTX4L3OX	26,8W	3000K	3720 Lm	1130mm
BNORTX4L4OX	26,8W	4000K	4000 Lm	1130mm
BNORTX4H3OX	38W	3000K	5600 Lm	1130mm
BNORTX4H4OX	38W	4000K	6000 Lm	1130mm
BNORTX6L3OX	40,2W	3000K	5580 Lm	1690mm
BNORTX6L4OX	40,2W	4000K	6000 Lm	1690mm
BNORTX6H3OX	57W	3000K	8400 Lm	1690mm
BNORTX6H4OX	57W	4000K	9000 Lm	1690mm

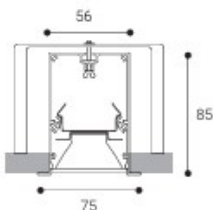

Blanc = B
Noir = N

Puissance	25,9-57W ⚡
Couleur de Température (K)	2,7-5,6K 2,7-6,5K 3000K 4000K
Lumens	3345-9000Lm 💡
Dimensions	56x85xLmm 📏
Options	DALI ✓ DALI/PUSH ✓ ⚙️

L70B10
50.000h

UGR
16

IP
30

IRC
>80

References	Puissances	K	Lumens	Dimensions (L)
BNORTXE4L3RX	26,8W	3000K	3720 Lm	1126mm
BNORTXE4L4RX	26,8W	4000K	4000 Lm	1126mm
BNORTXE4H3RX	38W	3000K	5600 Lm	1126mm
BNORTXE4H4RX	38W	4000K	6000 Lm	1126mm
BNORTXE6L3RX	40,2W	3000K	5580 Lm	1688mm
BNORTXE6L4RX	40,2W	4000K	6000 Lm	1688mm
BNORTXE6H3RX	57W	3000K	8400 Lm	1688mm
BNORTXE6H4RX	57W	4000K	9000 Lm	1688mm

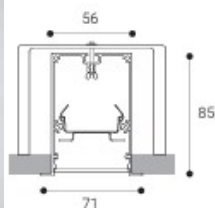

L70B10
60.000h

UGR
22

IP
30

IRC
>80

References	Puissances	K	Lumens	Dimensions (L)
BNORTXE4L3OX	26,8W	3000K	3720 Lm	1130mm
BNORTXE4L4OX	26,8W	4000K	4000 Lm	1130mm
BNORTXE4H3OX	38W	3000K	5600 Lm	1130mm
BNORTXE4H4OX	38W	4000K	6000 Lm	1130mm
BNORTXE6L3OX	40,2W	3000K	5580 Lm	1690mm
BNORTXE6L4OX	40,2W	4000K	6000 Lm	1690mm
BNORTXE6H3OX	57W	3000K	8400 Lm	1690mm
BNORTXE6H4OX	57W	4000K	9000 Lm	1690mm

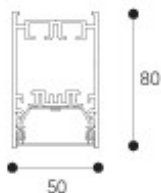

Blanc = B
Gris = G

Puissance

| 26,8-57W ⚡

Couleur de Température (K)

| 3000K | 4000K 🌞

Lumens

| 3720-9000Lm 💡

Dimensions

| 50x80xLmm 📏

Options

| DALI ✓ | DALI/PUSH ✓ ⚙️

L70B10
60.000h

UGR
19

IP
30

IRC
>80

References	Puissances	K	Lumens	Dimensions (L)
BNORLI4L3OBX	26,8W	3000K	3720 Lm	1125mm
BNORLI4L4OBX	26,8W	4000K	4000 Lm	1125mm
BNORLI4H3OBX	38W	3000K	5600 Lm	1125mm
BNORLI4H4OBX	38W	4000K	6000 Lm	1125mm
BNORLI6L3OBX	40,2W	3000K	5580 Lm	1685mm
BNORLI6L4OBX	40,2W	4000K	6000 Lm	1685mm
BNORLI6H3OBX	57W	3000K	8400 Lm	1685mm
BNORLI6H4OBX	57W	4000K	9000 Lm	1685mm

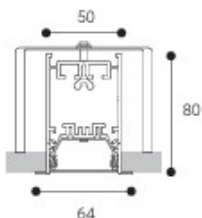

L70B10
60.000h

UGR
19

IP
30

IRC
>80

References	Puissances	K	Lumens	Dimensions (L)
BNORLE4L3OBX	26,8W	3000K	3720 Lm	1125mm
BNORLE4L4OBX	26,8W	4000K	4000 Lm	1125mm
BNORLE4H3OBX	38W	3000K	5600 Lm	1125mm
BNORLE4H4OBX	38W	4000K	6000 Lm	1125mm
BNORLE6L3OBX	40,2W	3000K	5580 Lm	1685mm
BNORLE6L4OBX	40,2W	4000K	6000 Lm	1685mm
BNORLE6H3OBX	57W	3000K	8400 Lm	1685mm
BNORLE6H4OBX	57W	4000K	9000 Lm	1685mm

PROFIL

SLIM

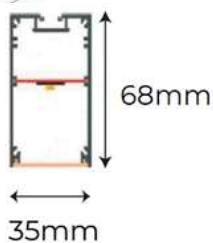
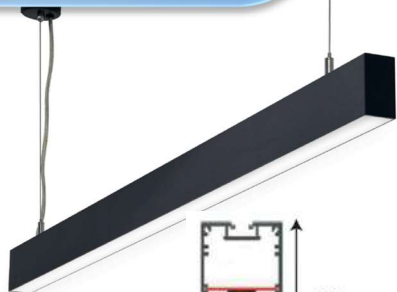

Blanc = B
Noir = N

Puissance	16-48W ⚡
Couleur de Température (K)	3000K 4000K 🌞
Lumens	1850-4850Lm 💡
Dimensions	35x68xLmm 📏
Options	DALI ✓ DALI/PUSH ✓ ⚡

L80B10
50.000h

UGR
<19

IP
40

IRC
>80

References	Puissances	K	Lumens	Dimensions (L)
BLAE996463X	16W	3000K	1850 Lm	570mm
BLAE996470X	16W	4000K	1850 Lm	570mm
BLAE996487X	32W	3000K	3250 Lm	1130mm
BLAE996494X	32W	4000K	3250 Lm	1130mm
BLAE996500X	40W	3000K	4100 Lm	1410mm
BLAE996517X	40W	4000K	4100 Lm	1410mm
BLAE996524X	48W	3000K	4850 Lm	1690mm
BLAE996531X	48W	4000K	4850 Lm	1690mm

SLIM INFINITY

Puissance	19-57W ⚡
Couleur de Température (K)	3000K 4000K 🌞
Lumens	2000-6075Lm 💡
Dimensions	35x68xLmm 📏
Options	DALI ✓ DALI/PUSH ✓ ⚡

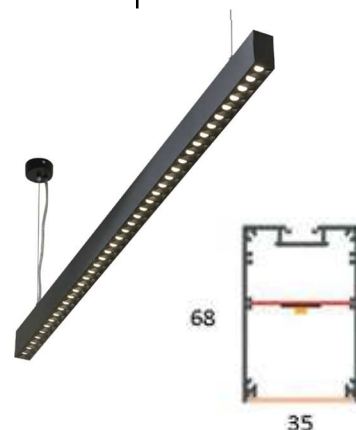

IP: 40

L80B10:
50.000h

UGR: 19

IRC: >80

References	Puissances	K	Lumens	Dimensions (L)
BLAE996630X	19W	3000K	2000 Lm	536mm
BLAE996647X	19W	4000K	2000 Lm	536mm
BLAE996654X	38W	3000K	4000 Lm	1068mm
BLAE996661X	38W	4000K	4000 Lm	1068mm
BLAE996678X	47W	3000K	5060 Lm	1334mm
BLAE996685X	47W	4000K	5060 Lm	1334mm
BLAE996692X	57W	3000K	6075 Lm	1600mm
BLAE996708X	57W	4000K	6075 Lm	1600mm

MADERA



Blanc = B
Noir = N

<u>Puissance</u>	30-37W ⚡
<u>Couleur de Température (K)</u>	3000K 4000K 🌈
<u>Lumens</u>	3500-4300Lm 💡
<u>Dimensions</u>	100x102xLmm 📏
<u>Options</u>	DALI ✓ DALI/PUSH ✓ ⚡

L80B10
50.000h

UGR
<19

IP
40

IRC
>80

References	Puissances	K	Lumens	Dimensions (L)
BLAE996418X	30W	3000K	3500 Lm	1156mm
BLAE996425X	30W	4000K	3500 Lm	1156mm
BLAE996432X	37W	3000K	4000 Lm	1436mm
BLAE996449X	37W	4000K	4000 Lm	1436mm

MADERA SLIM



<u>Puissance</u>	30-37W ⚡
<u>Couleur de Température (K)</u>	3000K 4000K 🌈
<u>Lumens</u>	3500-4300Lm 💡
<u>Dimensions</u>	102x85xLmm 📏
<u>Options</u>	DALI ✓ DALI/PUSH ✓ ⚡

L80B10
50.000h

UGR
<19

IP
40

IRC
>80

References	Puissances	K	Lumens	Dimensions (L)
BLAE996418X	30W	3000K	3500 Lm	1156mm
BLAE996425X	30W	4000K	3500 Lm	1156mm
BLAE996432X	37W	3000K	4000 Lm	1436mm
BLAE996449X	37W	4000K	4000 Lm	1436mm

4031

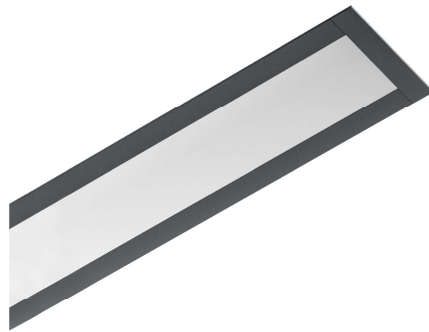

<u>Puissance</u>	6-108W ⚡
<u>Couleur de Température (K)</u>	2,7K 3K 4K 5K 6500K 🌈
<u>Lumens</u>	1100-19800Lm💡
<u>Dimensions</u>	67x75xLmm 📏
<u>Options</u>	DALI ✓ DALI/PUSH ✓ ⚙️

Opale = O | Prismatique = P Aluminium = A
| Noir = B | Rail Triphasé = C

L90B50
50.000h
IP
20
IP
40
IRC
90

Blanc = 1 | Gris = 2 | Gris Satin = 3 | Brossé = 4 | Graphite = 7 | Noir = 9 | Sur demande = 0

4032

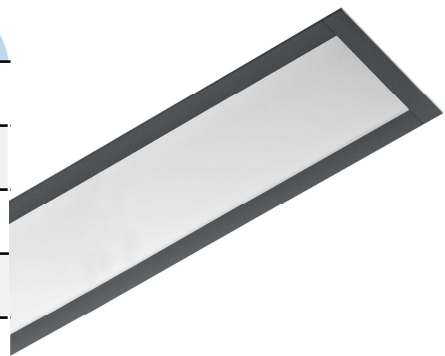

<u>Puissance</u>	6-108W ⚡
<u>Couleur de Température (K)</u>	2,7K 3K 4K 5K 6500K 🌈
<u>Lumens</u>	1100-19800Lm💡
<u>Dimensions</u>	85x75xLmm 📏
<u>Options</u>	DALI ✓ DALI/PUSH ✓ ⚙️

L90B50
50.000h
IP
20
IP
40
IRC
90

Opale = O | Prismatique = P
Aluminium = A | Noir = B

Blanc = 1 | Gris = 2 | Gris Satin = 3 | Brossé = 4 | Graphite = 7 | Noir = 9 | Sur demande = 0

4033

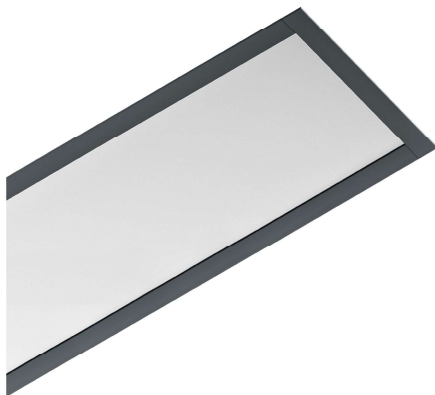

<u>Puissance</u>	6-108W ⚡
<u>Couleur de Température (K)</u>	2,7K 3K 4K 5K 6500K 🌈
<u>Lumens</u>	1100-19800Lm💡
<u>Dimensions</u>	120x90xLmm 📏
<u>Options</u>	DALI ✓ DALI/PUSH ✓ ⚙️

L90B50
50.000h
IP
20
IP
40
IRC
90

Opale = O | Prismatique = P | Aluminium = A

Blanc = 1 | Gris = 2 | Gris Satin = 3 | Brossé = 4 | Graphite = 7 | Noir = 9 | Sur demande = 0

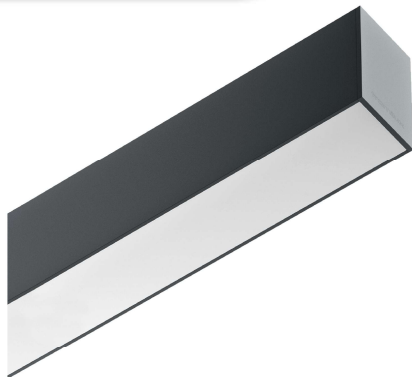

4041

<u>Puissance</u>	6-108W ⚡
<u>Couleur de Température (K)</u>	2,7K 3K 4K 5K 6500K 🌈
<u>Lumens</u>	1100-19800Lm💡
<u>Dimensions</u>	47x75xLmm 📏
<u>Options</u>	DALI ✓ DALI/PUSH ✓ ⚙️

Opale = O | Prismatique = P Aluminium = A
| Noir = B | 3R= L

L90B50
50.000h
IP
20
IP
40
IRC
90

Blanc = 1 | Gris = 2 | Gris Satin = 3 | Brossé = 4 | Graphite = 7 | Noir = 9 | Sur demande = 0

4042

<u>Puissance</u>	6-108W ⚡
<u>Couleur de Température (K)</u>	2,7K 3K 4K 5K 6500K 2700K 3000K 4000K (3R) 🌈
<u>Lumens</u>	1100-19800Lm💡
<u>Dimensions</u>	65x75xLmm 📏
<u>Options</u>	DALI ✓ DALI/PUSH ✓ ⚙️



L90B10(3R)
50.000h
L90B50
50.000h
IP
20
IP
40
IRC
90

Opale = O | Prismatique = P
Aluminium = A | Noir = B
3R= L

Blanc = 1 | Gris = 2 | Gris Satin = 3 | Brossé = 4 | Graphite = 7 | Noir = 9 | Sur demande = 0

4043

<u>Puissance</u>	6-108W ⚡
<u>Couleur de Température (K)</u>	2,7K 3K 4K 5K 6500K 🌈
<u>Lumens</u>	1100-19800Lm💡
<u>Dimensions</u>	100x90xLmm 📏
<u>Options</u>	DALI ✓ DALI/PUSH ✓ ⚙️



L90B50
50.000h
IP
20
IP
40
IRC
90

Opale = O | Prismatique = P | Aluminium = A

Blanc = 1 | Gris = 2 | Gris Satin = 3 | Brossé = 4 | Graphite = 7 | Noir = 9 | Sur demande = 0

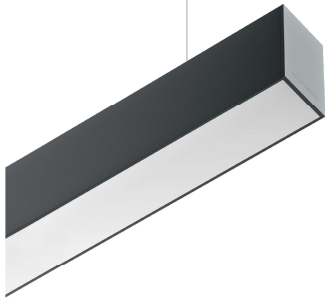

4051

<u>Puissance</u>	6-108W ⚡
<u>Couleur de Température (K)</u>	2,7K 3K 4K 5K 6500K 🌈
<u>Lumens</u>	1100-19800Lm💡
<u>Dimensions</u>	47x75xLmm 📏
<u>Options</u>	DALI ✓ DALI/PUSH ✓ ⚙️

Opale = O | Prismatique = P Aluminium = A
| Noir = B | Rail Triphasé = C

L90B50
50.000h
IP
20
IP
40
IRC
90

Blanc = 1 | Gris = 2 | Gris Satin = 3 | Brossé = 4 | Graphite = 7 | Noir = 9 | Sur demande = 0

4052

<u>Puissance</u>	6-108W ⚡
<u>Couleur de Température (K)</u>	2,7K 3K 4K 5K 6500K 2700K 3000K 4000K (3R) 🌈
<u>Lumens</u>	1100-19800Lm💡
<u>Dimensions</u>	65x75xLmm 📏
<u>Options</u>	DALI ✓ DALI/PUSH ✓ ⚙️

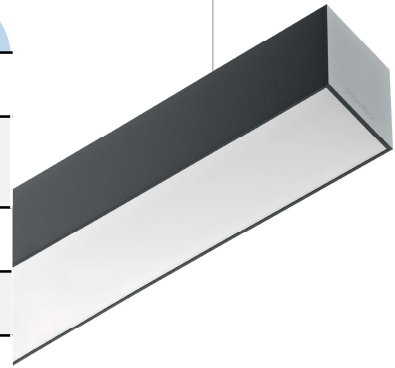

L90B10(3R)
50.000h
L90B50
50.000h
IP
20
IP
40
IRC
90

Opale = O | Prismatique = P
Aluminium = A | Noir = B
3R = L

Blanc = 1 | Gris = 2 | Gris Satin = 3 | Brossé = 4 | Graphite = 7 | Noir = 9 | Sur demande = 0

4053

<u>Puissance</u>	6-108W ⚡
<u>Couleur de Température (K)</u>	2,7K 3K 4K 5K 6500K 🌈
<u>Lumens</u>	1100-19800Lm💡
<u>Dimensions</u>	100x90xLmm 📏
<u>Options</u>	DALI ✓ DALI/PUSH ✓ ⚙️





L90B50
50.000h
IP
20
IP
40
IRC
90

Opale = O | Prismatique = P | Aluminium = A

Blanc = 1 | Gris = 2 | Gris Satin = 3 | Brossé = 4 | Graphite = 7 | Noir = 9 | Sur demande = 0

References	Puissances	K	Lumens	Dimensions (L)
BTROXXXX.029.XXL	6W	2,7/3/4/5/6500K	1100 Lm	290mm
BTROXXXX.043.XXL	9W	2,7/3/4/5/6500K	1650 Lm	430mm
BTROXXXX.057.XXL	12W	2,7/3/4/5/6500K	2200 Lm	570mm
BTROXXXX.071.XXL	15W	2,7/3/4/5/6500K	2750 Lm	710mm
BTROXXXX.085.XXL	18W	2,7/3/4/5/6500K	3300 Lm	850mm
BTROXXXX.099.XXL	21W	2,7/3/4/5/6500K	3850 Lm	990mm
BTROXXXX.113.XXL	24W	2,7/3/4/5/6500K	4400 Lm	1130mm
BTROXXXX.127.XXL	27W	2,7/3/4/5/6500K	4950 Lm	1270mm
BTROXXXX.141.XXL	30W	2,7/3/4/5/6500K	5500 Lm	1410mm
BTROXXXX.155.XXL	33W	2,7/3/4/5/6500K	6050 Lm	1550mm
BTROXXXX.169.XXL	36W	2,7/3/4/5/6500K	6600 Lm	1690mm
BTROXXXX.183.XXL	39W	2,7/3/4/5/6500K	7150 Lm	1830mm
BTROXXXX.197.XXL	42W	2,7/3/4/5/6500K	7700 Lm	1970mm
BTROXXXX.211.XXL	45W	2,7/3/4/5/6500K	8250 Lm	2110mm
BTROXXXX.225.XXL	48W	2,7/3/4/5/6500K	8800 Lm	2250mm
BTROXXXX.239.XXL	51W	2,7/3/4/5/6500K	9350Lm	2390mm
BTROXXXX.253.XXL	54W	2,7/3/4/5/6500K	9900Lm	2530mm
BTROXXXX.267.XXL	57W	2,7/3/4/5/6500K	10450Lm	2670mm
BTROXXXX.281.XXL	60W	2,7/3/4/5/6500K	11000Lm	2810mm
BTROXXXX.295.XXL	63W	2,7/3/4/5/6500K	11550Lm	2950mm
BTROXXXX.309.XXL	66W	2,7/3/4/5/6500K	12100Lm	3090mm
BTROXXXX.323.XXL	69W	2,7/3/4/5/6500K	12650Lm	3230mm
BTROXXXX.337.XXL	72W	2,7/3/4/5/6500K	13200Lm	3370mm
BTROXXXX.351.XXL	75W	2,7/3/4/5/6500K	13750Lm	3510mm
BTROXXXX.365.XXL	78W	2,7/3/4/5/6500K	14300Lm	3650mm
BTROXXXX.379.XXL	81W	2,7/3/4/5/6500K	14850Lm	3790mm
BTROXXXX.393.XXL	84W	2,7/3/4/5/6500K	15400Lm	3930mm
BTROXXXX.407.XXL	87W	2,7/3/4/5/6500K	15950Lm	4070mm
BTROXXXX.421.XXL	90W	2,7/3/4/5/6500K	16500Lm	4210mm
BTROXXXX.435.XXL	93W	2,7/3/4/5/6500K	17050Lm	4350mm
BTROXXXX.449.XXL	96W	2,7/3/4/5/6500K	17600Lm	4490mm
BTROXXXX.463.XXL	99W	2,7/3/4/5/6500K	18150Lm	4630mm
BTROXXXX.477.XXL	102W	2,7/3/4/5/6500K	18700Lm	4770mm
BTROXXXX.491.XXL	105W	2,7/3/4/5/6500K	19250Lm	4910mm
BTROXXXX.505.XXL	108W	2,7/3/4/5/6500K	19800Lm	5050mm

4530-4531

<u>Puissance</u>	3-67W ⚡
<u>Couleur de Température (K)</u>	2,7K 3K 4K 5K 6500K
<u>Lumens</u>	490-12250Lm 💡
<u>Dimensions</u>	36x25xLmm 
<u>Options</u>	DALI ✓ DALI/PUSH ✓ 

L80B10
80.000h
(4530)

L70
50.000h
(4531)

L70B10
54.000h
(4531)

IP
40(4530)

IP
65(4531)



IRC
>80(4530)

IRC
>90(4531)
80(4531)

Opale = O | Noir = B

Blanc = 1 | Gris = 2 | Gris Satin = 3 | Brossé = 4 | Graphite = 7 | Noir = 9 | Sur demande = 0

4540-4541

<u>Puissance</u>	3-67W ⚡
<u>Couleur de Température (K)</u>	2,7K 3K 4K 5K 6500K
<u>Lumens</u>	490-12250Lm 💡
<u>Dimensions</u>	26x25xLmm 
<u>Options</u>	DALI ✓ DALI/PUSH ✓ 

L80B10
80.000h
(4540)

L70
50.000h
(4541)

L70B10
54.000h
(4541)

IP
40(4540)

IP
65(4541)



IRC
>80(4540)

IRC
>90(4541)
80(4541)

Opale = O | Noir = B

Blanc = 1 | Gris = 2 | Gris Satin = 3 | Brossé = 4 | Graphite = 7 | Noir = 9 | Sur demande = 0

4550-4551

<u>Puissance</u>	3-67W ⚡
<u>Couleur de Température (K)</u>	2,7K 3K 4K 5K 6500K
<u>Lumens</u>	490-12250Lm 💡
<u>Dimensions</u>	26x25xLmm 
<u>Options</u>	DALI ✓ DALI/PUSH ✓ 

L80B10
80.000h
(4550)

L70
50.000h
(4551)

L70B10
54.000h
(4551)

IP
40(4550)

IP
65(4551)

IRC
>80(4550)

IRC
>90(4551)
80(4551)

Opale = O | Noir = B

Blanc = 1 | Gris = 2 | Gris Satin = 3 | Brossé = 4 | Graphite = 7 | Noir = 9 | Sur demande = 0

4530-4531

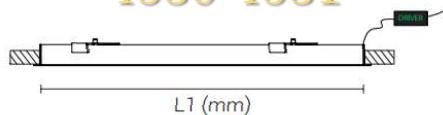

4540-4541

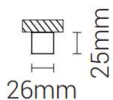
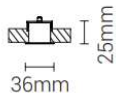
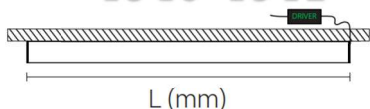

4550-4551

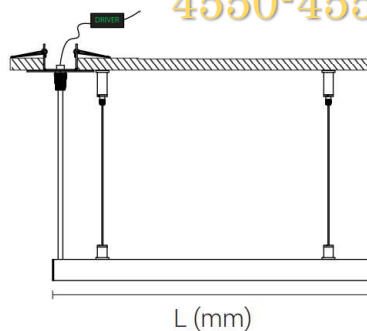

XXXX = 4530-4531 | 4540-4541 | 4550-4551

Opale = O | Noir = B

Blanc = 1 | Gris = 2 | Gris Satin = 3 | Brossé = 4 | Graphite = 7 | Noir = 9 | Sur demande = 0

References	Puissances	K	Lumens	Dimensions (L)
BTROXXXX.015.XXL	3W	2,7/3/4/5/6500K	490 Lm	155mm
BTROXXXX.029.XXL	5W	2,7/3/4/5/6500K	980 Lm	295mm
BTROXXXX.043.XXL	8W	2,7/3/4/5/6500K	1470 Lm	435mm
BTROXXXX.057.XXL	11W	2,7/3/4/5/6500K	1960 Lm	575mm
BTROXXXX.071.XXL	13W	2,7/3/4/5/6500K	2450 Lm	715mm
BTROXXXX.085.XXL	16W	2,7/3/4/5/6500K	2940 Lm	855mm
BTROXXXX.099.XXL	19W	2,7/3/4/5/6500K	3430 Lm	995mm
BTROXXXX.113.XXL	21W	2,7/3/4/5/6500K	3920 Lm	1135mm
BTROXXXX.127.XXL	24W	2,7/3/4/5/6500K	4410 Lm	1275mm
BTROXXXX.141.XXL	27W	2,7/3/4/5/6500K	4900 Lm	1415mm
BTROXXXX.155.XXL	29W	2,7/3/4/5/6500K	5390 Lm	1555mm
BTROXXXX.169.XXL	32W	2,7/3/4/5/6500K	5880 Lm	1695mm
BTROXXXX.183.XXL	35W	2,7/3/4/5/6500K	6370 Lm	1835mm
BTROXXXX.197.XXL	37W	2,7/3/4/5/6500K	6860 Lm	1975mm
BTROXXXX.211.XXL	40W	2,7/3/4/5/6500K	7350 Lm	2115mm
BTROXXXX.225.XXL	43W	2,7/3/4/5/6500K	7840Lm	2255mm
BTROXXXX.239.XXL	45W	2,7/3/4/5/6500K	8330Lm	2395mm
BTROXXXX.253.XXL	48W	2,7/3/4/5/6500K	8820Lm	2535mm
BTROXXXX.267.XXL	50W	2,7/3/4/5/6500K	9310Lm	2675mm
BTROXXXX.281.XXL	53W	2,7/3/4/5/6500K	9800Lm	2815mm
BTROXXXX.295.XXL	56W	2,7/3/4/5/6500K	10290Lm	2955mm
BTROXXXX.309.XXL	59W	2,7/3/4/5/6500K	10780Lm	3095mm
BTROXXXX.323.XXL	61W	2,7/3/4/5/6500K	11270Lm	3235mm
BTROXXXX.337.XXL	64W	2,7/3/4/5/6500K	11760Lm	3375mm
BTROXXXX.351.XXL	67W	2,7/3/4/5/6500K	12250Lm	3515mm

L90B10
50.000h

IRC
>84

IP
40(4530)

IP
65(4531)

Puissance	33W ⚡
Couleur de Température (K)	3000K 4000K
Lumens	2070Lm 💡
Dimensions	55x72xLmm
Options	DALI ✓ DALI/PUSH ✓ ⚡

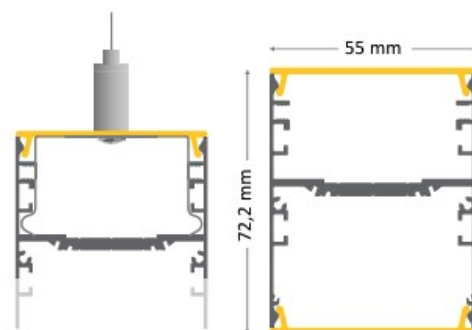
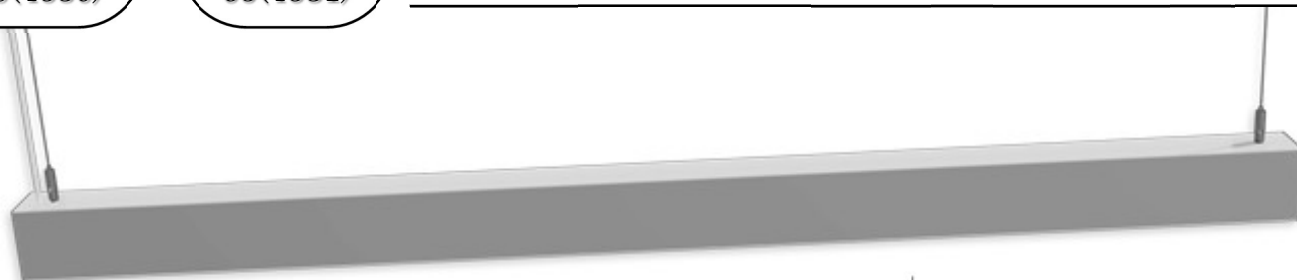

References	Largeur	Hauteur	Longueur
BACT5572S600	55mm	72,2mm	644mm
BACT5572S1200	55mm	72,2mm	1204mm
BACT5572S1800	55mm	72,2mm	1764mm
BACT5572S2300	55mm	72,2mm	2324mm
BACT5572S2900	55mm	72,2mm	2884mm

Suspendu	K	Diffuseur
	830 (3000K)	PCPO(Opale)
	840 (4000K)	PCPC(Clair)

BACT5572	S				
-----------------	----------	--	--	--	--

Example:

- BACT5572S120084056PCPOL4
- BACT557260083028PCPCSCE

Longueur	W	Options
600 (644mm)	28	Lx Câble personnalisé : longueur x en mètre
1200 (1204mm)	56	SCE Sortie de câble sur une extrémité
1800 (1764mm)	84	xxxx Profilé couleur RAL spécifique
2300 (2324mm)	122	
2900 (2884mm)	144	

L90B10
50.000h

IRC
>84

IP
40

IP
54

Puissance

| 13-33W ⚡

Couleur de Température (K)

| 3000K | 4000K | 5000K

Lumens

| 2400Lm 💡

Dimensions

| 50x50xLmm

Options

| DALI ✓ | DALI/PUSH ✓ ⚡

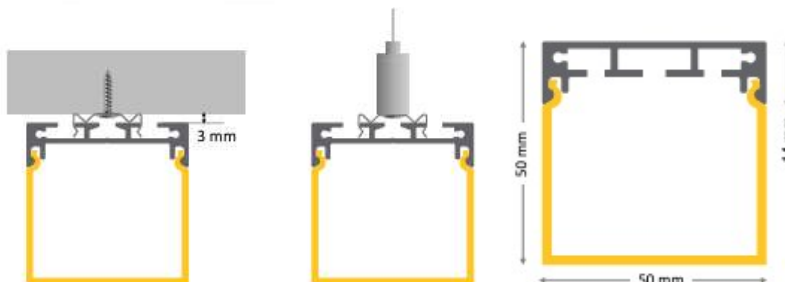

References	Largeur	Hauteur	Longueur
BACT5050A600	50mm	50mm	604mm
BACT5050A1200	50mm	50mm	1164mm
BACT5050A1800	50mm	50mm	1724mm
BACT5050A2300	50mm	50mm	2284mm
BACT5050A2900	50mm	50mm	2844mm

S (Suspendu)

A (Applique)

K

830 (3000K)

840 (4000K)

850 (5000K)

Diffuseur

PCPO(Opale)

BACT5572	---	---	---	---	---
-----------------	-----	-----	-----	-----	-----

Example:

- BACT5572S120084056PCPOL4
- BACT557260083028PCPCSC

Longueur	W			
600 (604mm)	8	12	16	20
1200 (1164mm)	16	24	32	40
1800 (1724mm)	24	36	48	60
2300 (2284mm)	32	48	64	80
2900 (2844mm)	40	60	80	100

Options

Lx

Câble personnalisé : longueur x en mètre

SCE

Sortie de câble sur une extrémité

xxxx

Profilé couleur RAL spécifique

SCD

Sortie de câble arrière déporté de 10cm

IP54

Protection niveau IP54

PROFIL

L80F10
72.000h

IP
40

IRC
>80

LINEA SALIENTE

Puissance | 18-153W ⚡

Couleur de Température (K) | 3000K | 4000K | 6000K | TW

Lumens | 2200-18700Lm

Dimensions | 55x49xLmm

Options | DALI ✓ | DALI/PUSH ✓

VERSION APLIQUE DE PAREDE



LINEA SALIENTE SLIM

Puissance | 18-153W ⚡

Couleur de Température (K) | 3000K | 4000K | 6000K | TW

Lumens | 570-18700Lm

Dimensions | 14,5x49xLmm

Options | DALI ✓ | DALI/PUSH ✓

IP
40

IP
68

IRC
>80

L80F10
72.000h

VERSION EMBUTIDA C (Avec Rabat)



LINEA EMBUTIDA

Puissance | 18-153W ⚡

Couleur de Température (K) | 3000K | 4000K | 6000K | TW

Lumens | 2200-18700Lm

Dimensions | 63,5x92,70xLmm

Options | DALI ✓ | DALI/PUSH ✓

VERSION EMBUTIDA C (Avec Rabat)

IP
40

L80F10
72.000h

IRC
>80

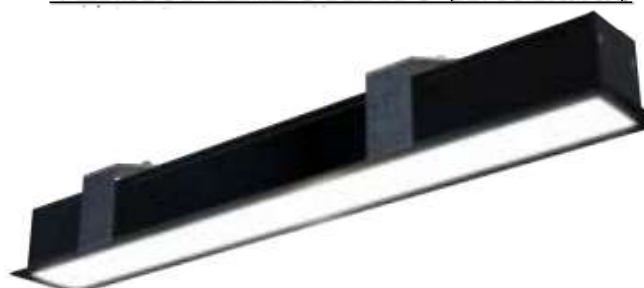

PROFIL

L80F10
72.000h

IP
40

IRC
>80



LINEA SUSPENSA

Puissance | 18-306W ⚡

Couleur de Température (K) | 3000K | 4000K | 6000K | TW

Lumens | 2200-37400Lm

Dimensions | 55x49xLmm | 55x120xLmm

Options | DALI ✓ | DALI/PUSH ✓

VERSION DOUBLE



LINEA SUSPENSA UP DOWN

Puissance | 36-612W ⚡

Couleur de Température (K) | 3000K | 4000K | 6000K | TW

Lumens | 570-74800Lm

Dimensions | 14,5x49xLmm

Options | DALI ✓ | DALI/PUSH ✓

IP
40

IRC
>80

L80F10
72.000h

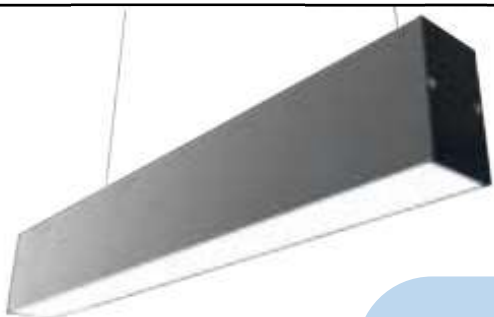

VERSION DOUBLE



LINEA INDUSTRIA

Puissance | 18-153W ⚡

Couleur de Température (K) | 3000K | 4000K | 6000K | TW

Lumens | 2200-18700Lm

Dimensions | 68x29xLmm

Options | DALI ✓ | DALI/PUSH ✓

VERSION SUSPENSA

L80F10
72.000h

IP
40

IRC
>80



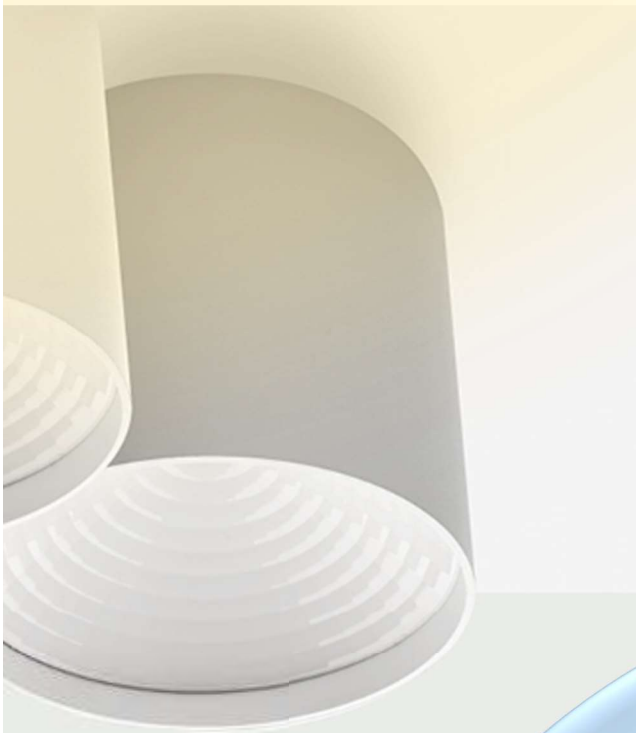

PLAFONNIER

HAT S



<u>Puissance</u>	17W ⚡
<u>Couleur de Température (K)</u>	3000K 4000K 5000K 6000K
<u>Lumens</u>	1800-1920Lm 💡
<u>Dimensions</u>	Ø220mm
<u>Options</u>	DALI ✓ DALI/PUSH ✓ ≡

L70B10
72.000h
UGR
22
IRC
>80
IP
30

Blanc = B | Gris = G | Noir = N

References	Puissances	K	Lumens	Dimensions (L)
BNOREHS23X	17W	3000K	1800 Lm	Ø220mm
BNOREHS24X	17W	4000K	1900 Lm	Ø220mm
BNOREHS25X	17W	5000K	1920 Lm	Ø220mm
BNOREHS26X	17W	6000K	1920 Lm	Ø220mm

ELIT S

<u>Puissance</u>	6,4-17,4W ⚡
<u>Couleur de Température (K)</u>	3000K 4000K
<u>Lumens</u>	760-2850Lm 💡
<u>Dimensions</u>	Ø69mm Ø198mm
<u>Options</u>	DALI ✓ DALI/PUSH ✓ ≡



L70F10
72.000h
UGR
19
IRC
>80
IP
20-54

Blanc = B | Gris = G | Noir = N

References	Puissances	K	Lumens	Dimensions (L)
BNOREPA03X	6,4W	3000K	760 Lm	Ø69mm
BNOREPA04X	6,4W	4000K	885 Lm	Ø69mm
BNORELA23X	11,8W	3000K	1930 Lm	Ø198mm
BNORELA24X	11,8W	4000K	2050 Lm	Ø198mm
BNORELA33X	17,4W	3000K	2650 Lm	Ø198mm
BNORELA34X	17,4W	4000K	2850 Lm	Ø198mm

PLAFONNIER SUSPENSION



CYRE

<u>Puissance</u>	6,4-17,4W ⚡
<u>Couleur de Température (K)</u>	3000K 4000K 🌈
<u>Lumens</u>	760-2850Lm 💡
<u>Dimensions</u>	Ø198mm Ø69mm 📏
<u>Options</u>	DALI ✓ DALI/PUSH ✓ ⚙️

L70B10
60.000h

UGR
19

IRC
>80

IP
20

Blanc = B | Gris = G | Noir = N

References	Puissances	K	Lumens	Dimensions (L)
BNORCYP03X	6,4W	3000K	760 Lm	Ø69mm
BNORCYP04X	6,4W	4000K	885 Lm	Ø69mm
BNORCYL23X	11,8W	3000K	1930 Lm	Ø198mm
BNORCYL24X	11,8W	4000K	2050 Lm	Ø198mm
BNORCYL33X	17,4W	3000K	2650 Lm	Ø198mm
BNORCYL34X	17,4W	4000K	2850 Lm	Ø198mm

BLOS ROUND

<u>Puissance</u>	26W ⚡
<u>Couleur de Température (K)</u>	3000K 🌈
<u>Lumens</u>	1930-8450Lm 💡
<u>Dimensions</u>	Ø230mm 📏
<u>Options</u>	DALI ✓ DALI/PUSH ✓ ⚙️

IRC
>90

IP
54

L70F10
72.000h

UGR
19

Version Surface

BAQ47019M930



Version Suspension

BAQ59864M930S



Version IP ELEVE

BAQ47019IK10M930



Noir = 12 | Blanc = 13 | Gris = 16 | Cuivre = 17 | Or = 19

References	Puissances	K	Lumens	Dimensions (L)
BAQ59864M930SX	26W	3000K	2730 Lm	Ø320mm
BAQ47019M930X	26W	3000K	2730 Lm	Ø320mm
BAQ47019IK10M930X	26W	3000K	2730 Lm	Ø320mm

PLAFONNIER

TUBA 50



Puissance	8,5 50W ⚡
Couleur de Température (K)	2700K 3000K (GU10) 🌞
Lumens	670-1420Lm (GU10) 💡
Dimensions	Ø96mm Ø85mm (🌀)
Options	DALI ✓ DALI/PUSH ✓ ⚡

IRC
>90

Noir = 12 | Blanc = 13 | Gris = 16 | Cuivre = 17 | Or = 19

References	Puissances	K	Lumens	Dimensions (L)
BAQ45921X	50W	(GU10)	(GU10)	Ø96mm
BAQ46975M927X	8,5W	2700K	670 Lm	Ø85mm
BAQ46975M930X	8,5W	3000K	710 Lm	Ø85mm
BAQ47017M927X	17W	2700K	1350 Lm	2x Ø85mm
BAQ47017M930X	17W	3000K	1420 Lm	2x Ø85mm

TUBA 111

Puissance	8W 100W ⚡
Couleur de Température (K)	2700K 3000K 4000K (GU10) (G53) 🌞
Lumens	720-1080Lm (GU10) (G53) 💡
Dimensions	Ø140mm (🌀)
Options	DALI ✓ DALI/PUSH ✓ ⚡



Noir = 12 | Blanc = 13 | Gris = 16 | Cuivre = 17 | Or = 19

IRC
>90

References	Puissances	K	Lumens	Dimensions (L)
BAQ40222L927X	8W	2700K	720 Lm	Ø140mm
BAQ40222M927X	11W	2700K	970 Lm	Ø140mm
BAQ40222L930X	8W	3000K	740 Lm	Ø140mm
BAQ40222M930X	11W	3000K	1020 Lm	Ø140mm
BAQ40222L940X	8W	4000K	790 Lm	Ø140mm
BAQ40222M940X	11W	4000K	1080 Lm	Ø140mm
BAQ45602X	50W	(GU10)	(GU10)	Ø140mm
BAQ45603X	12W	(G53)	(G53)	Ø140mm
BAQ45630X	24W	(G53)	(G53)	2x Ø140mm
BAQ45632X	100W	(GU10)	(GU10)	2x Ø140mm
BAQ45611X	11W	(G53)	(G53)	Ø140mm
BAQ45711X	50W	(GU10)	(GU10)	Ø140mm

PLAFONNIER SUSPENSION

BAQ47026



BAQ38031



IRC
>90

MINI RING RIM

Puissance

| 14,5W ⚡

Couleur de Température (K)

| 3000K | 4000K

Lumens

| <1500Lm 💡

Dimensions

| Ø180mm | Ø169mm

Options

| DALI ✓ | DALI/PUSH ✓ ⚡

Noir = 12 | Blanc = 13 | Gris = 16 | Cuivre = 17 | Or = 19

References	Puissances	K	Lumens	Dimensions (L)
BAQ47026M930X	14,5W	3000K	<1500 Lm	Ø180mm
BAQ47026M940X	14,5W	4000K	<1630 Lm	Ø180mm
BAQ38031M930X	14,5W	3000K	<1500 Lm	Ø169mm
BAQ38031M940X	14,5W	4000K	<1630 Lm	Ø169mm

BIG SIZE NEXT ROUND

Puissance

| 10,5W – 17,5W ⚡

Couleur de Température (K)

| 2700K | 3000K | 4000K

Lumens

| 1500-19620Lm 💡

Dimensions

| Ø450mm | Ø660mm | Ø960mm | Ø1220mm

Options

| DALI ✓ | DALI/PUSH ✓ ⚡



BAQ59788
BAQ50259
BAQ50261
BAQ50263



BAQ46976
BAQ40237
BAQ40238
BAQ40239

IP
20

IRC
>90

L80F50
72.000h

Noir = 12 | Blanc = 13 | Gris = 16 | Cuivre = 17 | Or = 19

References	Puissances	K	Lumens	Dimensions (L)
BAQ59788A927X	11,5-19,5W	2700K	... Lm	Ø450mm
BAQ59788A930X	11,5-19,5W	3000K	1090-1940 Lm	Ø450mm
BAQ59788A940X	11,5-19,5W	4000K	1210-2160 Lm	Ø450mm
BAQ50259A927X	25,5-42,5W	2700K	... Lm	Ø660mm
BAQ50259A930X	25,5-42,5W	3000K	2370-4220 Lm	Ø660mm
BAQ50259A940X	25,5-42,5W	4000K	2630-4680 Lm	Ø660mm
BAQ50261A927X	44-78W	2700K	... Lm	Ø960mm
BAQ50261A930X	44-78W	3000K	4390-7810 Lm	Ø960mm
BAQ50261A940X	44-78W	3000K	4860-8650 Lm	Ø960mm
BAQ50263A927X	81-143W	2700K	... Lm	Ø1220mm
BAQ50263A930X	81-143W	3000K	8050-14320 Lm	Ø1220mm
BAQ50263A940X	81-143W	4000K	8920-15860 Lm	Ø1220mm



INDUSTRIELLE SPORTIF



<u>Puissance</u>	17,8-54W ⚡
<u>Couleur de Température (K)</u>	4000K 6000K 🌞
<u>Lumens</u>	2250-8250Lm 💡
<u>Dimensions</u>	53x41mm 📏
<u>Options</u>	DALI ✓ DALI/PUSH ✓ ⚡

L70B10 54.000h	UGR 22	IRC >80	IP 66
--------------------------	------------------	-------------------	-----------------

Détecteur = S

References	Puissances	K	Lumens	Dimensions (L)
BNORDV18X	17,8W	4000K	2250 Lm	600mm
BNORDV18X-6	17,8W	6000K	2475 Lm	600mm
BNORDV36X	32,4W	4000K	4500 Lm	1100mm
BNORDV36X-6	32,4W	6000K	4950 Lm	1100mm
BNORDV60X	54W	4000K	7500 Lm	1500mm
BNORDV60X-6	54W	6000K	8250 Lm	1500mm

BLOK AVANT

<u>Puissance</u>	90,9-181,8W ⚡
<u>Couleur de Température (K)</u>	4000K 5700K 🌞
<u>Lumens</u>	15000-30070Lm 💡
<u>Dimensions</u>	Ø290mm 📏
<u>Options</u>	DALI ✓ DALI/PUSH ✓ ⚡



L70B10 50.000h	UGR 22	IRC >80	IP 67
--------------------------	------------------	-------------------	-----------------

Optique intensive = SN
Optique moyen = MN
Optique étendue = FN

References	Puissances	K	Lumens	Dimensions (L)
BNORBK100-4XX	90,9W	4000K	15000 Lm	Ø290mm
BNORBK100-5XX	90,9W	5700K	15030 Lm	Ø290mm
BNORBK150-4XX	136,4W	4000K	22500 Lm	Ø290mm
BNORBK150-5XX	136,4W	5700K	22550 Lm	Ø290mm
BNORBK200-4XX	181,8W	4000K	30000 Lm	Ø290mm
BNORBK200-5XX	181,8W	5700K	30070 Lm	Ø290mm



<u>Puissance</u>	100-200W ⚡
<u>Couleur de Température (K)</u>	4000K 5000K 🌈
<u>Lumens</u>	13118-26574Lm 💡
<u>Dimensions</u>	Ø220mm Ø330mm 📏
<u>Options</u>	DALI ✓ DALI/PUSH ✓ ⚡

L70B50
50.000h

IRC
>80

IP
65

References	Puissances	K	Lumens	Dimensions (L)
BPRI468961	100W	4000K	13118 Lm	Ø220mm
BPRI468978	100W	5000K	13281 Lm	Ø220mm
BPRI468985	150W	4000K	19815 Lm	Ø330mm
BPRI468992	150W	5000K	21007 Lm	Ø330mm
BPRI469005	200W	4000K	26089 Lm	Ø330mm
BPRI469012	200W	5000K	26574 Lm	Ø330mm

KELA

<u>Puissance</u>	100-200W ⚡
<u>Couleur de Température (K)</u>	4000K 5000K 🌈
<u>Lumens</u>	13680-28019Lm 💡
<u>Dimensions</u>	Ø300mm Ø360mm 📏
<u>Options</u>	DALI ✓ DALI/PUSH ✓ ⚡



L70B10
50.000h

IRC
>80

IP
65

References	Puissances	K	Lumens	Dimensions (L)
BPRI469388	100W	4000K	13680 Lm	Ø300mm
BPRI469395	100W	5000K	13985 Lm	Ø300mm
BPRI469401	150W	4000K	20737 Lm	Ø300mm
BPRI469418	150W	5000K	21034 Lm	Ø300mm
BPRI469425	200W	4000K	27412 Lm	Ø360mm
BPRI469432	200W	5000K	28019 Lm	Ø360mm



TUB70

<u>Puissance</u>	18-W ⚡
<u>Couleur de Température (K)</u>	4000K 🟡
<u>Lumens</u>	2160-Lm 💡
<u>Dimensions</u>	Ø70mm 📏
<u>Options</u>	DALI ✓ DALI/PUSH ✓ ☰



= BIDE827006

Détecteur

UGR
<26

L80B10
54.000h

IRC
>80

IP
69K

<u>References</u>	<u>Puissances</u>	<u>K</u>	<u>Lumens</u>	<u>Dimensions (L)</u>
BIDE827005	18W	4000K	2160 Lm	600mm
BIDE827001	36W	4000K	4320 Lm	1200mm
BIDE827006	36W	4000K	4320 Lm	1200mm
BIDE827002	50W	4000K	6000 Lm	1500mm

TOULOUSE

<u>Puissance</u>	30-100W ⚡
<u>Couleur de Température (K)</u>	2700K 4000K 6000K 🟡
<u>Lumens</u>	10000-Lm 💡
<u>Dimensions</u>	330x268mm 📏
<u>Options</u>	DALI ✓ DALI/PUSH ✓ ☰



L70B10
50.000h

IRC
>80

IP
66

UGR
>26

<u>References</u>	<u>Puissances</u>	<u>K</u>	<u>Lumens</u>	<u>Dimensions (L)</u>
BIDE917011	30-50-75-100W	3CCT	10000 Lm	330x268mm
BIDE917012	60-100-150-200W	3CCT	20000 Lm	412x360mm
BIDE917020	60-100-150-200W	3CCT	28000 Lm	412x360mm
BIDE917013	200-400-500-600W	3CCT	78000 Lm	412x360mm

IP
66

UGR
>26

L70B10
100.000h

IRC
>70

Puissance

| 35-118,4W ⚡

Couleur de Température (K) | 3000-4000K



Lumens

| 5825-15770Lm 💡

Dimensions

| 500x250mm 

Options

| DALI ✓ | DALI/PUSH ✓ 



650x350

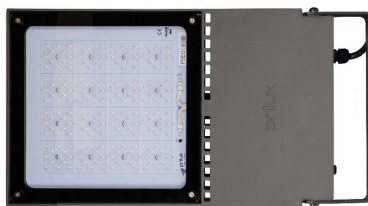

560x250



500x250

References	Puissances	K	Lumens	Dimensions (L)
BPRI575454	38W	3000-4000K	5825 Lm	500x250mm
BPRI519878	38W	3000-4000K	6270 Lm	500x250mm
BPRI575461	51W	3000-4000K	8086 Lm	500x250mm
BPRI519847	51W	3000-4000K	8704 Lm	500x250mm
BPRI575485	73W	3000-4000K	10897 Lm	500x250mm
BPRI519892	73W	3000-4000K	11730 Lm	500x250mm
BPRI575478	110W	3000-4000K	14650 Lm	500x250mm
BPRI519915	110W	3000-4000K	15770 Lm	500x250mm
BPRI575492	62W	3000-4000K	10358 Lm	560x250mm
BPRI519922	62W	3000-4000K	11290 Lm	560x250mm
BPRI571999	92W	3000-4000K	14455 Lm	560x250mm
BPRI520010	92W	3000-4000K	15756 Lm	560x250mm
BPRI575508	130W	3000-4000K	19184 Lm	560x250mm
BPRI520027	130W	3000-4000K	20910 Lm	560x250mm
BPRI575515	189W	3000-4000K	25230 Lm	560x250mm
BPRI520034	189W	3000-4000K	27500 Lm	560x250mm
BPRI575522	97W	3000-4000K	15966 Lm	650x350mm
BPRI520041	97W	3000-4000K	17340 Lm	650x350mm
BPRI575546	140W	3000-4000K	21937 Lm	650x350mm
BPRI520058	140W	3000-4000K	23826 Lm	650x350mm
BPRI575539	201W	3000-4000K	29556 Lm	650x350mm
BPRI520065	201W	3000-4000K	32100 Lm	650x350mm
BPRI566681	304W	3000-4000K	39500 Lm	650x350mm
BPRI520072	304W	3000-4000K	42900 Lm	650x350mm

PROFIL

TUBE 40

IRC
>84

L90B10
50.000h

IP
66

<u>Puissance</u>	6-60W ⚡
<u>Couleur de Température (K)</u>	2700K 3000K 4000K 5000K
<u>Lumens</u>	2070Lm 💡
<u>Dimensions</u>	55x72xLmm 🌀
<u>Options</u>	DALI ✓ DALI/PUSH ✓ ⚡

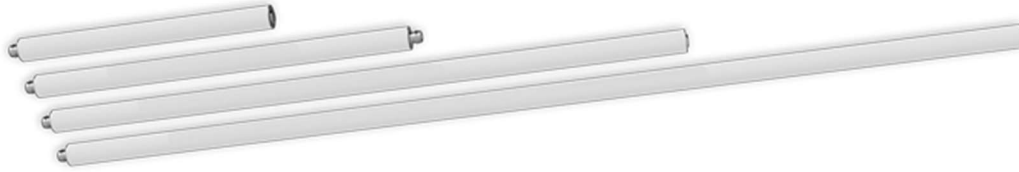

FCR	FCM	FCBF
FCO	FCJ	FCBC
FCRS	K	FCV
	827 (2700K)	
	830 (3000K)	Diffuseur
	840 (4000K)	PCPO(Opale)
	850 (5000K)	PCPC(Clair)

Chainable

BACTTUBE40	C				
-------------------	----------	--	--	--	--

Example:

- BACTTUBE40C40082714PCPOFCR
- BACTTUBE40120083032PCPCLNX

Longueur	W			
400 (498mm)	6	14		
600 (695mm)	8	12	16	20
1200 (1255mm)	16	24	32	40
1800 (1815mm)	24	36	48	60

Options	
LNx	Câble personnalisé Noir : longueur x en mètre
LBx	Câble personnalisé Blanc : longueur x en mètre
FCxx	Filtre de couleur

Version RGB

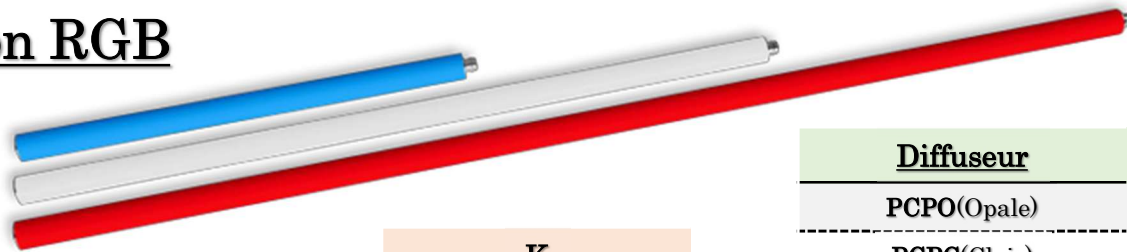

K
RGB830 (RGB+3000K)
RGB840 (RGB+4000K)

Diffuseur
PCPO(Opale)
PCPC(Clair)
PC20(Clair faisceau 20°)
PC60(Clair faisceau 60°)

BACTTUBE40S				
--------------------	--	--	--	--

Example:

- BACTTUBE40C40082714PCPOFCR
- BACTTUBE40120083032PCPCLNX

Longueur	W
600 (680mm)	10
1200 (1240mm)	21
1800 (1800mm)	31

IRC
>84

IP
66

L90B10
50.000h

IRC
>80

L90B10
60.000h

IP
65

<u>Puissance</u>	18-90W ⚡
<u>Couleur de Température (K)</u>	3000K 4000K 🌞
<u>Lumens</u>	2160-10860Lm 💡
<u>Dimensions</u>	265x380mm 📏
<u>Options</u>	DALI ✓ DALI/PUSH ✓ ⚡

GURU AS

GURU R

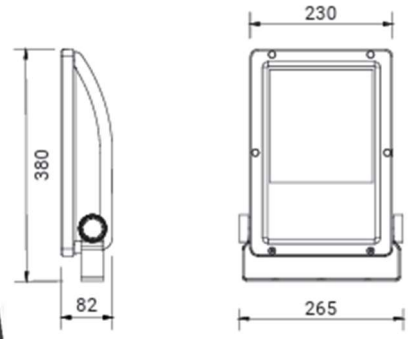

X = W (3000K) ou N (4000K)

<u>References</u>	<u>Puissances</u>	<u>K</u>	<u>Lumens</u>	<u>Dimensions (L)</u>
BIDKGU14005ASX08	18W	3000K 4000K	2165 Lm	265x380mm
BIDKGU14007ASX08	26W	3000K 4000K	2980 Lm	265x380mm
BIDKGU14008ASX08	31W	3000K 4000K	3490 Lm	265x380mm
BIDKGU14010ASX08	40W	3000K 4000K	4330 Lm	265x380mm
BIDKGU14014ASX08	54W	3000K 4000K	5595 Lm	265x380mm
BIDKGU18016ASX08	90W	3000K 4000K	9365 Lm	265x380mm
BIDKGU24010ASX08	81W	3000K 4000K	8885 Lm	265x380mm
BIDKGU14005RX08	18W	3000K 4000K	2515 Lm	265x380mm
BIDKGU14007RX08	26W	3000K 4000K	3460 Lm	265x380mm
BIDKGU14008RX08	31W	3000K 4000K	4010 Lm	265x380mm
BIDKGU14010RX08	40W	3000K 4000K	5020 Lm	265x380mm
BIDKGU14014RX08	54W	3000K 4000K	6520Lm	265x380mm
BIDKGU18016RX08	91W	3000K 4000K	10860Lm	265x380mm

IRC
>80

L90B10
60.000h

IRC
>70

IP
65

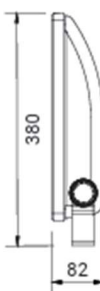

CRI >70= KGT732405 - KGT732410

CRI >80= KGT832405 - KGT832410

Puissance	37-80,5W ⚡
Couleur de Température (K)	AMBER 3000K 4000K 🌈
Lumens	3105-8890Lm 💡
Dimensions	265x380mm 📏
Options	DALI ✓ DALI/PUSH ✓ ⚡

References	Puissances	K	Lumens	Dimensions (L)
BIDKGT32405ASAW08	37W	AMBER	3240 Lm	265x380mm
BIDKGT832405ASW08	37W	3000K	4160 Lm	265x380mm
BIDKGT832405ASN08	37W	4000K	4350 Lm	265x380mm
BIDKGT732405ASW08	37W	3000K	4545 Lm	265x380mm
BIDKGT732405ASN08	37W	4000K	4805 Lm	265x380mm
BIDKGT32410ASAW08	80W	AMBER	6390 Lm	265x380mm
BIDKGT832410ASW08	80,5W	3000K	7575 Lm	265x380mm
BIDKGT832410ASN08	80,5W	4000K	7950 Lm	265x380mm
BIDKGT732410ASW08	79W	3000K	8460 Lm	265x380mm
BIDKGT732410ASN08	79W	4000K	8890 Lm	265x380mm
BIDKGT32405CAW08	37W	AMBER	3105 Lm	265x380mm
BIDKGT832405CW08	37W	3000K	3985 Lm	265x380mm
BIDKGT832405CN08	37W	4000K	4170 Lm	265x380mm
BIDKGT732405CW08	37W	3000K	4355 Lm	265x380mm
BIDKGT732405CN08	37W	4000K	4605 Lm	265x380mm
BIDKGT32410CAW08	80W	AMBER	6125 Lm	265x380mm
BIDKGT832410CW08	80,5W	3000K	7260 Lm	265x380mm
BIDKGT832410CN08	80,5W	4000K	7615 Lm	265x380mm
BIDKGT732410CW08	79W	3000K	8105 Lm	265x380mm
BIDKGT732410CN08	79W	4000K	8952 Lm	265x380mm

IRC
>80

L90B10
60.000h

IRC
>70

IP
65



Puissance

| 37-80,5W ⚡

Couleur de Température (K)

| AMBER | 3000K | 4000K

Lumens

| 2935-8750Lm 💡

Dimensions

| 265x380mm

Options

| DALI ✓ | DALI/PUSH ✓ ⚡

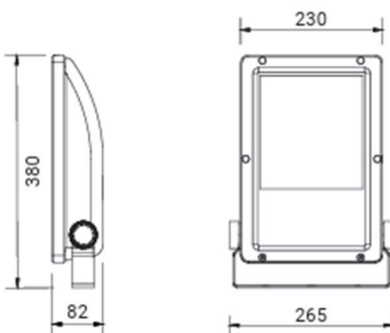

CRI >70= KGT732405 - KGT732410

CRI >80= KGT832405 - KGT832410

References	Puissances	K	Lumens	Dimensions (L)
BIDKGT32405CPAW08	37W	AMBER	3190 Lm	265x380mm
BIDKGT832405CPW08	37W	3000K	4095 Lm	265x380mm
BIDKGT832405CPN08	37W	4000K	4200 Lm	265x380mm
BIDKGT732405CPW08	37W	3000K	4470 Lm	265x380mm
BIDKGT732405CPN08	37W	4000K	4730 Lm	265x380mm
BIDKGT32410CPN08	80W	AMBER	6290 Lm	265x380mm
BIDKGT832410CPW08	80,5W	3000K	7455 Lm	265x380mm
BIDKGT832410CPN08	80,5W	4000K	7820 Lm	265x380mm
BIDKGT732410CPW08	79W	3000K	8325 Lm	265x380mm
BIDKGT732410CPN08	79W	4000K	8750 Lm	265x380mm
BIDKGT32405STAW08	37W	AMBER	2935 Lm	265x380mm
BIDKGT832405STW08	37W	3000K	3765 Lm	265x380mm
BIDKGT832405STN08	37W	4000K	3940 Lm	265x380mm
BIDKGT732405STW08	37W	3000K	4115 Lm	265x380mm
BIDKGT732405STN08	37W	4000K	4355 Lm	265x380mm
BIDKGT32410STAW08	80W	AMBER	5785 Lm	265x380mm
BIDKGT832410STW08	80,5W	3000K	6860 Lm	265x380mm
BIDKGT832410STN08	80,5W	4000K	7195 Lm	265x380mm
BIDKGT732410STW08	79W	3000K	7660 Lm	265x380mm
BIDKGT732410STN08	79W	4000K	8050 Lm	265x380mm

<u>Puissance</u>	18-90W ⚡
<u>Couleur de Température (K)</u>	AMBER 3000K 4000K 🌈
<u>Lumens</u>	2160-10860Lm 💡
<u>Dimensions</u>	265x380mm 📏
<u>Options</u>	DALI ✓ DALI/PUSH ✓ ⚡

L90B10
60.000h

IRC
>80

IP
65

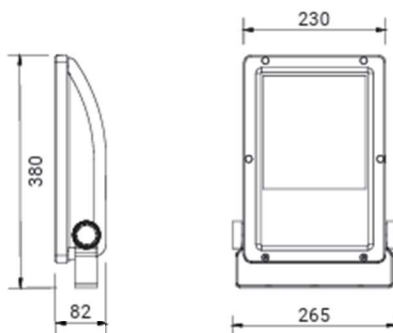

CRI >70= KGT732405 - KGT732410

CRI >80= KGT832405 - KGT832410

X = W (3000K) ou N (4000K)

<u>References</u>	<u>Puissances</u>	<u>K</u>	<u>Lumens</u>	<u>Dimensions (L)</u>
BIDKGP16016ASX08	95W	3000K 4000K	9155 Lm	265x380mm
BIDKGP16018ASX08	107W	3000K 4000K	10100 Lm	265x380mm
BIDKGP18022ASX08	132W	3000K 4000K	12410 Lm	265x380mm
BIDKGP18027ASX08	160W	3000K 4000K	14730 Lm	265x380mm
BIDKGP24010ASX08	80W	3000K 4000K	8870 Lm	265x380mm
BIDKGP24014ASX08	90W	3000K 4000K	11185 Lm	265x380mm
BIDKGP26008ASX08	90W	3000K 4000K	9870 Lm	265x380mm
BIDKGP26010ASX08	120W	3000K 4000K	12650 Lm	265x380mm
BIDKGP26014ASX08	165W	3000K 4000K	16990 Lm	265x380mm
BIDKGP26017ASX08	198W	3000K 4000K	19775 Lm	265x380mm
BIDKGP16016RX08	95W	3000K 4000K	10620 Lm	265x380mm
BIDKGP16018RX08	107W	3000K 4000K	11720 Lm	265x380mm
BIDKGP18022RX08	132W	3000K 4000K	14395 Lm	265x380mm
BIDKGP18027RX08	160W	3000K 4000K	17090 Lm	265x380mm
BIDKGT732405STN08	37W	3000K 4000K	4355 Lm	265x380mm
BIDKGT32410STAW08	80W	3000K 4000K	5785 Lm	265x380mm
BIDKGT832410STW08	80,5W	3000K 4000K	6860 Lm	265x380mm
BIDKGT832410STN08	80,5W	3000K 4000K	7195 Lm	265x380mm
BIDKGT732410STW08	79W	3000K 4000K	7660 Lm	265x380mm
BIDKGT732410STN08	79W	3000K 4000K	8050 Lm	265x380mm

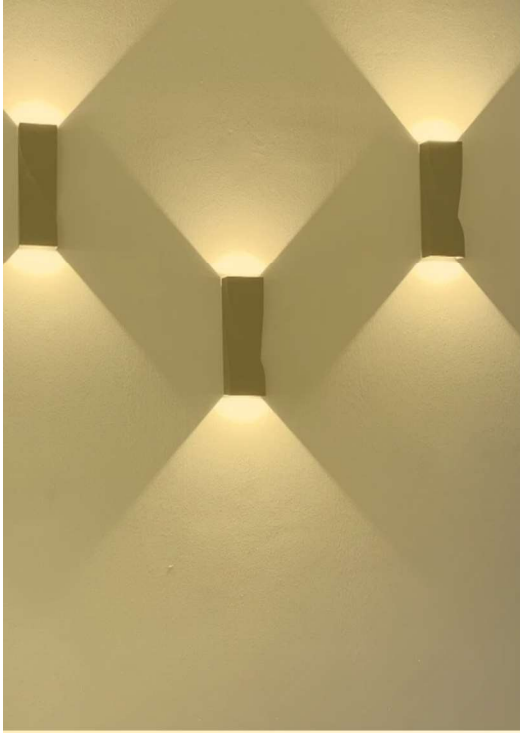

EXTERIEUR

IBIZA & MARBELLA



<u>Puissance</u>	18W - 32W ⚡
<u>Couleur de Température (K)</u>	3000K - 4000K - 6000K 🌈
<u>Lumens</u>	1800 Lm - 3100 Lm 💡
<u>Dimensions</u>	Ø238mm Ø320mm 📏
<u>Options</u>	DALI ✓ DALI/PUSH ✓ ⚙️

UGR
<19

IP
65
(BIDE478010)

IP
54
(BIDE563002)

IRC
>80

L80B10
50.000h

<u>References</u>	<u>Puissances</u>	<u>K</u>	<u>Lumens</u>	<u>Dimensions</u>
BIDE563002	18W	3000-4000-6000K	1800 Lm	Ø238mm
BIDE478010	32W	3000-4000-6000K	3100 Lm	Ø320mm

MALAGA & VALENCE

<u>Puissance</u>	20W - 30W ⚡
<u>Couleur de Température (K)</u>	3000K - 4000K - 6000K 🌈
<u>Lumens</u>	1800 Lm - 3000 Lm 💡
<u>Dimensions</u>	Ø355mm 📏
<u>Options</u>	DALI ✓ DALI/PUSH ✓ ⚙️



COLLERETTE ASYMETRIQUE POUR GAMME VALENCE

UGR
<25

IP
65

IRC
>80

L80B10
50.000h



BIDE563013 Ø270mm



BIDE563014 Ø270mm

<u>References</u>	<u>Puissances</u>	<u>K</u>	<u>Lumens</u>	<u>Dimensions</u>
BIDE563008	20W	3000-4000-6000K	1800 Lm	Ø270mm
BIDE563009	30W	3000-4000-6000K	3000 Lm	Ø355mm

TONDA 260 & 330



BLOMLL591P(IP65)

BLOMLL802P(IP65)

BLOMLB53221(IP66)

<u>Puissance</u>	18W ⚡
<u>Couleur de Température (K)</u>	3000K 4000K
<u>Lumens</u>	1950 Lm 💡
<u>Dimensions</u>	Ø260mm Ø265mm Ø330mm
<u>Options</u>	DALI ✓ DALI/PUSH ✓ ⚡

IP 66
IP 65
IP 44
IRC >80
L80B20 50.000h

(👁️) Détecteur Ou (🔋 3h) Batterie de 3h Couleurs : BLANC (1), NOIR (2), GRIS (G)

References	Puissances	K	Lumens	Dimensions
BLOMLL591PX	18W	3000K/4000K	1950 Lm	Ø260mm
BLOMLL802PX	18W	3000K/4000K	1950 Lm	Ø260mm
BLOMLB5322X	(E27)	(E27)	(E27)	Ø265mm
BLOMLL581BX	18W	3000K/4000K	1950 Lm	Ø330mm

DODO



BLOMLL14301

BLOMLL14302

BLOMLL14303

BLOMLL14304

BLOMLL14305

<u>Puissance</u>	3W - 30W ⚡
<u>Couleur de Température (K)</u>	2700K 3000K 4000K
<u>Lumens</u>	360 Lm - 2900 Lm 💡
<u>Dimensions</u>	63x63 103x100 302x100mm
<u>Options</u>	DALI ✓ DALI/PUSH ✓ ⚡

IP 54
IRC >80
L80B20 50.000h

Couleurs : BLANC (W), GRIS (L), GRIS FONCE (D), DOREE(Z), NOIR (B)

References	Puissances	K	Lumens	Dimensions
BLOMLL14301X	3W	2700-3000-4000K	360 Lm	63x63x63mm
BLOMLL14302X	3W	2700-3000-4000K	360 Lm	63x63x157mm
BLOMLL14303X	8W	2700-3000-4000K	1180 Lm	103x100x100mm
BLOMLL14304X	8W	2700-3000-4000K	1180 Lm	103x100x250mm
BLOMLL14305X	20W	2700-3000-4000K	2900 Lm	57x302x100mm



ROSS 330

<u>Puissance</u>	30W ⚡
<u>Couleur de Température (K)</u>	2700K 3000K 4000K
<u>Lumens</u>	3000 Lm 💡
<u>Dimensions</u>	Ø330mm 📏
<u>Options</u>	DALI ✓ DALI/PUSH ✓ ⚡

IP
66

IRC
>80

L80B20
50.000h

☞ Détecteur | ⚡_{3h} Batterie de 3h | ☞ Détecteur crépusculaire | ☞ Fonction corridor

References	Puissances	K	Lumens	Dimensions
○ BLOMLL124010	25W	2700K/3000K/4000K	3000 Lm	Ø330mm
● BLOMLL124011	25W	2700K/3000K/4000K	3000 Lm	Ø330mm
○ BLOMLL124012	25W	2700K/3000K/4000K	3000 Lm	Ø330mm
● BLOMLL124013	25W	2700K/3000K/4000K	3000 Lm	Ø330mm
● BLOMLL124014	25W	2700K/3000K/4000K	3000 Lm	Ø330mm

ART100

<u>Puissance</u>	10W ⚡
<u>Couleur de Température (K)</u>	2700K 3000K 4000K
<u>Lumens</u>	1100 Lm 💡
<u>Dimensions</u>	250x100x55mm 📏
<u>Options</u>	DALI ✓ DALI/PUSH ✓ ⚡

BLOMLL116000



BLOMLL116006



BLOMLL116001



BLOMLL116002



IP
66

IRC
>80

L80B20
50.000h

☞ Détecteur (BLOMLL116002)

☞ Détecteur crépusculaire (BLOMLL116002)

Couleurs : BLANC (1), NOIR (2), GRIS (3), GRIS FONCE (4), BORDEAUX (5)

References	Puissances	K	Lumens	Dimensions
BLOMLL116000	10W	2700-3000-4000K	1100 Lm	250x100x55mm
BLOMLL116006X	10W	2700-3000-4000K	1100 Lm	250x100x58mm
BLOMLL116001X	10W	2700-3000-4000K	1100 Lm	250x100x58mm
BLOMLL116002X	10W	2700-3000-4000K	1100 Lm	250x100x55mm

BLOMLL116100 BLOMLL116101



BLOMLL116102 BLOMLL116103



Puissance | 13W ⚡

Couleur de Température (K) | 2000K | 3000K | 4000K

Lumens | 2040 - 2200 Lm 💡

Dimensions | 250x250x55mm | 250x250x58mm

Options | DALI ✓ | DALI/PUSH ✓



Couleurs : BLANC (1), NOIR (2), GRIS (3), GRIS FONCE (4), BORDEAUX (5)

☞ Détecteur | ⚡ 3h Batterie de 3h | ☞ Détecteur crépusculaire | ☞ Fonction corridor

References	Puissances	K	Lumens	Dimensions
BLOMLL116100	20W	2700K/3000K/4000K	2200 Lm	250x250x55mm
BLOMLL116101	17W	2700K/3000K/4000K	2040 Lm	250x250x55mm
BLOMLL116102	17W	2700K/3000K/4000K	2040 Lm	250x250x58mm
BLOMLL116103	17W	2700K/3000K/4000K	2040 Lm	250x250x55mm

AGO APPLIQUE & UP

Puissance | 5W - 6W ⚡

Couleur de Température (K) | 2200K | 2700K | 3000K | 4000K

Lumens | 600 - 700 Lm 💡

Dimensions | Ø50mm

Options | DALI ✓ | DALI/PUSH ✓



BLOMLL12640
BLOMLL12641



BLOMLL12650



BLOMLL12620



BLOMLL12621

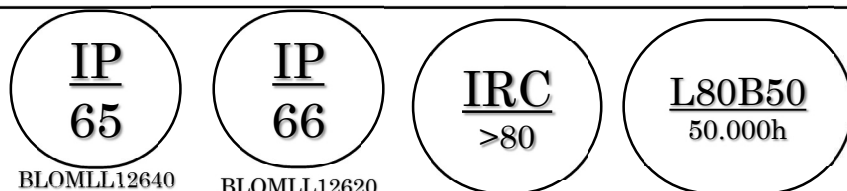

BLOMLL12640
BLOMLL12641
BLOMLL12650

BLOMLL12620
BLOMLL12621

Couleurs : BLANC (1), NOIR (2), GRIS (3), BORDEAUX (4)

References	Puissances	K	Lumens	Dimensions
BLOMLL12640	5W	2200-2700-3000-4000K	600 Lm	Ø50x70mm
BLOMLL12641	6W	2200-2700-3000-4000K	700 Lm	Ø50x70mm
BLOMLL12650	10W	2200-2700-3000-4000K	1100 Lm	Ø50x110mm
BLOMLL12620	5W	2200-2700-3000-4000K	600 Lm	Ø50x134mm
BLOMLL12621	10W	2200-2700-3000-4000K	1200 Lm	Ø50x134mm

EXTERIEUR

PISE



Puissance

| 13W ⚡

Couleur de Température (K)

| 3000K | 4000K | 6000K

Lumens

| 273 Lm 💡

Dimensions

| 223x130x105mm

Options

| DALI ✓ | DALI/PUSH ✓ ⚡

IP
65

IRC
>80

UGR
<19

L80B10
50.000h

References	Puissances	K	Lumens	Dimensions
BIDE572003	13W	3000K/4000K/6000K	273 Lm	223x130x105mm

PALERME

Puissance

| 13W ⚡

Couleur de Température (K)

| 3000K | 4000K | 6000K

Lumens

| 702 Lm 💡

Dimensions

| 248x117x70mm

Options

| DALI ✓ | DALI/PUSH ✓ ⚡

IP
65

IRC
>80

UGR
<19

L80B50
50.000h



References	Puissances	K	Lumens	Dimensions
BIDE572005	13W	3000-4000-6000K	702 Lm	248x117x70mm

GENES

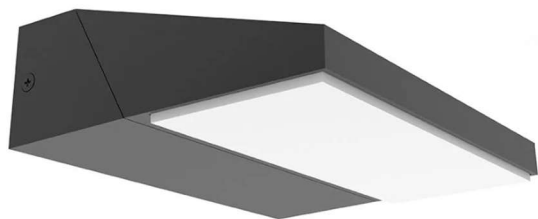

Puissance

| 13W ⚡

Couleur de Température (K)

| 3000K

Lumens

| 650 Lm 💡

Dimensions

| 172x141x52mm

Options

| DALI ✓ | DALI/PUSH ✓ ⚡

IP
65

IRC
>80

UGR
<19

L80B50
50.000h

References	Puissances	K	Lumens	Dimensions
BIDE572001	13W	3000K	650 Lm	172x141x52mm



SARDAIGNE

<u>Puissance</u>	10W ⚡
<u>Couleur de Température (K)</u>	3000K 🟡
<u>Lumens</u>	850 Lm 💡
<u>Dimensions</u>	161x211x59mm 📏
<u>Options</u>	DALI ✓ DALI/PUSH ✓ ⚡

IP
54

IRC
>80

UGR
<19

L80B10
50.000h



Détecteur Crépusculaire

<u>References</u>	<u>Puissances</u>	<u>K</u>	<u>Lumens</u>	<u>Dimensions</u>
BIDE572007	10W	3000K	850 Lm	161x211x59mm

TOURS

BIDE574001

BIDE574004



<u>Puissance</u>	20W ⚡
<u>Couleur de Température (K)</u>	3000K 4000K 6000K 🟡
<u>Lumens</u>	1400 Lm 💡
<u>Dimensions</u>	Ø168x800mm 📏
<u>Options</u>	DALI ✓ DALI/PUSH ✓ ⚡

IP
65

IRC
>80

UGR
10

L80B10
50.000h

<u>References</u>	<u>Puissances</u>	<u>K</u>	<u>Lumens</u>	<u>Dimensions</u>
BIDE574001	20W	3000-4000-6000K	1400 Lm	Ø168x800mm
BIDE574004	20W	3000-4000-6000K	1400 Lm	Ø168x800mm

BLOMLL12631 BLOMLL12632



BLOMLL12633 BLOMLL12634



BLOMLL12635



BLOMLL12636



AGO

Puissance

| 10W ⚡

Couleur de Température (K) | 2200K | 2700K | 3000K | 4000K

Lumens

| 1100 Lm 💡

Dimensions

| Ø58x300mm

Options

| DALI ✓ | DALI/PUSH ✓ ⚡

IP
66

IRC
>80

L80B50
50.000h

Couleurs : BLANC (1), NOIR (2), BORDEAUX (3)

<u>References</u>	<u>Puissances</u>	<u>K</u>	<u>Lumens</u>	<u>Dimensions</u>
BLOMLL12631X	10W	2200K/2700K/3000/4000K	1100 Lm	Ø58x300mm
BLOMLL12632X	10W	2200K/2700K/3000/4000K	1100 Lm	Ø58x300mm
BLOMLL12633X	10W	2200K/2700K/3000/4000K	1100 Lm	Ø58x600mm
BLOMLL12634X	10W	2200K/2700K/3000/4000K	1100 Lm	Ø58x600mm
BLOMLL12635X	10W	2200K/2700K/3000/4000K	1100 Lm	Ø58x900mm
BLOMLL12636X	10W	2200K/2700K/3000/4000K	1100 Lm	Ø58x900mm

LINE POST

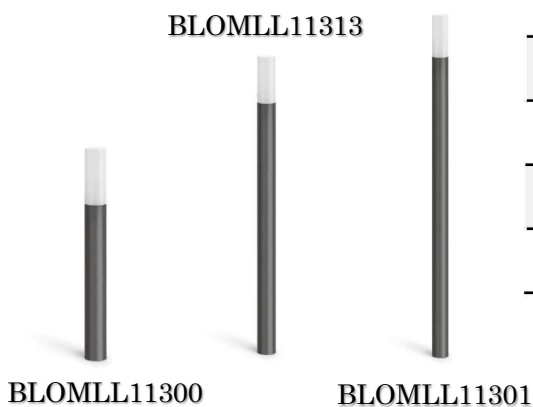

<u>Puissance</u>	6,5W ⚡
<u>Couleur de Température (K)</u>	2700K 3000K 4000K 🌈
<u>Lumens</u>	700 Lm 💡
<u>Dimensions</u>	Ø60x650mm 📏
<u>Options</u>	DALI ✓ DALI/PUSH ✓ ⚡

IP
66
IRC
>80
L80B20
50.000h

Couleurs : NOIR (6), GRIS (7), GRIS FONCE (8), BORDEAUX (3)

References	Puissances	K	Lumens	Dimensions
BLOMLL11300X	6,5W	2700K/3000/4000K	700 Lm	Ø60x650mm
BLOMLL11313X	6,5W	2700K/3000/4000K	700 Lm	Ø60x1150mm
BLOMLL11301X	6,5W	2700K/3000/4000K	700 Lm	Ø60x1650mm

STILE NEXT POST

<u>Puissance</u>	3W ⚡
<u>Couleur de Température (K)</u>	3000K 4000K 🌈
<u>Lumens</u>	310 Lm 💡
<u>Dimensions</u>	135x82mm 115x75mm 📏
<u>Options</u>	DALI ✓ DALI/PUSH ✓ ⚡

L80B20
50.000h
IRC
>80
IP
66

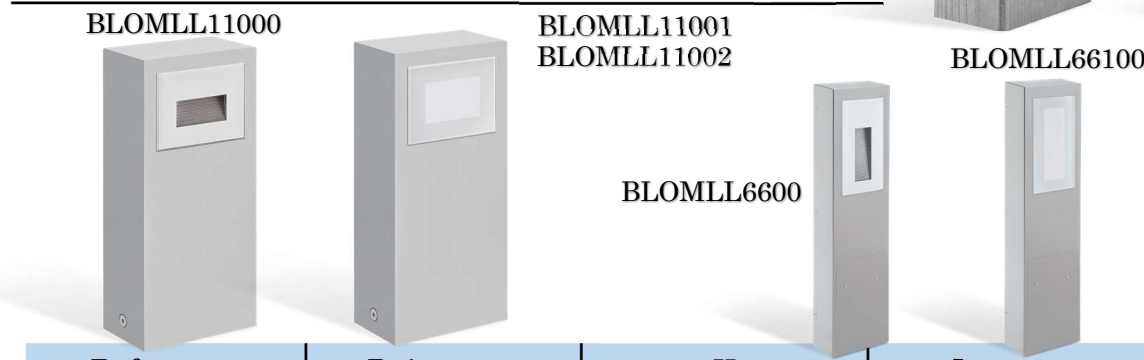

Couleurs :
NOIR (1)
GRIS (5)
BORDEAUX (9)



References	Puissances	K	Lumens	Dimensions
BLOMLL644C854	3W	3000/4000K	310 Lm	135x182x82mm
BLOMLL642C854	3W	3000/4000K	310 Lm	135x182x82mm
BLOMLL11000X	3W	3000/4000K	310 Lm	135x300x82mm
BLOMLL11001X	3W	3000/4000K	310 Lm	135x300x82mm
BLOMLL11002X	6W	3000/4000K	720 Lm	135x300x82mm
BLOMLL6600X	3W	3000/4000K	310 Lm	115x500x75mm
BLOMLL66100X	6W	3000/4000K	720 Lm	115x500x75mm

SOLARIS MINI ORIENTABLE



<u>Puissance</u>	14,4 – 20,7W ⚡
<u>Couleur de Température (K)</u>	3000K 4000K 🌞
<u>Lumens</u>	1121 - 2771 Lm 💡
<u>Dimensions</u>	160x167x57,5mm 📏
<u>Options</u>	DALI ✓ DALI/PUSH ✓ ⚡

SOLARIS MINI FISSO

IP
65

IRC
>90

L90B20
50.000h

<u>Puissance</u>	14,4 – 20,1W ⚡
<u>Couleur de Température (K)</u>	3000K 4000K 🌞
<u>Lumens</u>	1054 - 2143 Lm 💡
<u>Dimensions</u>	160x139x58mm 📏
<u>Options</u>	DALI ✓ DALI/PUSH ✓ ⚡



IP
65

IRC
>90

L90B20
50.000h



SOLARIS ORIENTABLE

<u>Puissance</u>	38,2 – 39,4W ⚡
<u>Couleur de Température (K)</u>	3000K 4000K 🌞
<u>Lumens</u>	5542 Lm 💡
<u>Dimensions</u>	220x240x65mm 📏
<u>Options</u>	DALI ✓ DALI/PUSH ✓ ⚡

IP
65

IRC
>90

L90B20
50.000h

SOLARIS FISSO

<u>Puissance</u>	38,2 – 44W ⚡
<u>Couleur de Température (K)</u>	3000K 4000K 🌞
<u>Lumens</u>	5278 - 5542 Lm 💡
<u>Dimensions</u>	220x160x66mm 📏
<u>Options</u>	DALI ✓ DALI/PUSH ✓ ⚡

IP
65

IRC
>90

L90B20
50.000h



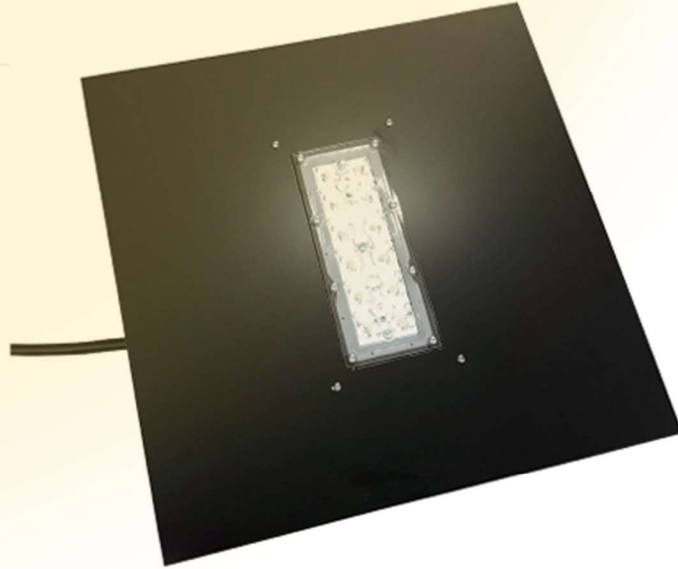
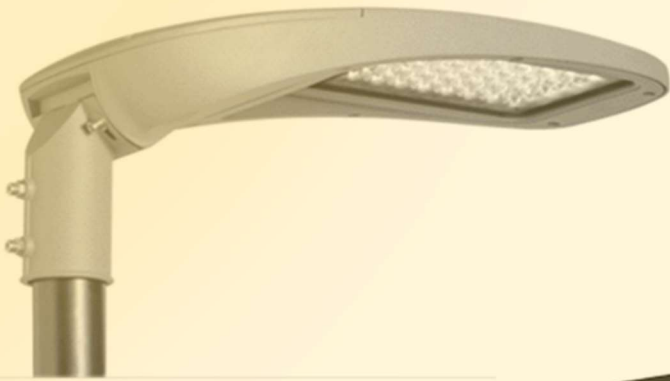

ECLAIRAGE PUBLIC

L90B10
200.000h

IRC
>70

IP
66



Puissance	32W ⚡
Couleur de Température (K)	4000K 🌞
Lumens	6397 Lm 💡
Dimensions	468x478x546mm 📏
Options	DALI ✓ DALI/PUSH ✓ ⚡

References	Puissances	K	Lumens	Dimensions
BPRI589819	32W	4000K	6397 Lm	468x478x546mm
BPRI589826	32W	4000K	6397 Lm	468x478x546mm
BPRI589833	32W	4000K	6397 Lm	468x478x546mm
BPRI589840	32W	4000K	6397 Lm	468x478x546mm

STILE NEXT POST

L90B10
50.000h

IRC
>70

IP
66

Puissance	13,3W – 100,9W ⚡
Couleur de Température (K)	3000K 4000K 🌞
Lumens	2292 Lm - 15907 Lm 💡
Dimensions	468x478x107mm 📏
Options	DALI ✓ DALI/PUSH ✓ ⚡



References	Puissances	K	Lumens	Dimensions
BPRI572781	13,3W	3000K	2292 Lm	468x478x107mm
BPRI572804	13,3W	4000K	2399 Lm	468x478x107mm
BPRI572835	18W	3000K	3163 Lm	468x478x107mm
BPRI572866	18W	4000K	3310 Lm	468x478x107mm
BPRI572880	24W	3000K	4239 Lm	468x478x107mm
BPRI572897	24W	4000K	4437 Lm	468x478x107mm
BPRI572903	36W	3000K	5700 Lm	468x478x107mm
BPRI572910	36W	4000K	5965 Lm	468x478x107mm
BPRI573009	32W	3000K	6113 Lm	468x478x107mm
BPRI573016	32W	4000K	6397 Lm	468x478x107mm
BPRI573023	48W	3000K	8435 Lm	468x478x107mm
BPRI573030	48W	4000K	8828 Lm	468x478x107mm
BPRI573047	64W	3000K	11305 Lm	468x478x107mm
BPRI573054	64W	4000K	11831 Lm	468x478x107mm
BPRI573061	96W	3000K	15200 Lm	468x478x107mm
BPRI573092	96W	4000K	15907 Lm	468x478x107mm

L90B10
200.000h

IRC
>70

IP
66



AVATAR

Puissance | 67,9W – 195W ⚡

Couleur de Température (K) | 3000K | 4000K 🌞

Lumens | 12226 - 30400 Lm 💡

Dimensions | 776x322x105mm 📏

Options | DALI ✓ | DALI/PUSH ✓ ➡

References	Puissances	K	Lumens	Dimensions
BPRI569569	67,9W	3000K	12226 Lm	776x322x105mm
BPRI569507	67,9W	4000K	12795 Lm	776x322x105mm
BPRI569576	97W	3000K	16870 Lm	776x322x105mm
BPRI569514	97W	4000K	17655 Lm	776x322x105mm
BPRI569606	135,1W	3000K	22610 Lm	776x322x105mm
BPRI569521	135,1W	4000K	23662 Lm	776x322x105mm
BPRI569613	152,8W	3000K	25307 Lm	776x322x105mm
BPRI569538	152,8W	4000K	26484 Lm	776x322x105mm
BPRI569620	175,1W	3000K	27900 Lm	776x322x105mm
BPRI569545	175,1W	4000K	29198 Lm	776x322x105mm
BPRI569637	195W	3000K	30400 Lm	776x322x105mm
BPRI569552	195W	4000K	30400 Lm	776x322x105mm

SFERA

Puissance | 18,8W – 74,6W ⚡

Couleur de Température (K) | 3000K | 4000K 🌞

Lumens | 3163 - 11930 Lm 💡

Dimensions | Ø500x580mm 📏

Options | DALI ✓ | DALI/PUSH ✓ ➡



L90B10
200.000h

IP
66

IRC
>70

References	Puissances	K	Lumens	Dimensions
BPRI569774	18,8W	3000K	3163 Lm	Ø500mm
BPRI569729	18,8W	4000K	3310 Lm	Ø500mm
BPRI569781	26,5W	3000K	4239 Lm	Ø500mm
BPRI569736	26,5W	4000K	4437 Lm	Ø500mm
BPRI569798	38,8W	3000K	5700 Lm	Ø500mm
BPRI569743	38,8W	4000K	5965 Lm	Ø500mm
BPRI569804	51,7W	3000K	8479 Lm	Ø500mm
BPRI569750	51,7W	4000K	8873 Lm	Ø500mm
BPRI569811	74,6W	3000K	11400 Lm	Ø500mm
BPRI569767	74,6W	4000K	11930 Lm	Ø500mm



IRCANA

<u>Puissance</u>	13,3W – 78,8W ⚡
<u>Couleur de Température (K)</u>	3000K 4000K 🌞
<u>Lumens</u>	2399 - 12654 Lm 💡
<u>Dimensions</u>	445x775mm 📏
<u>Options</u>	DALI ✓ DALI/PUSH ✓ ⚡

IP
65

IRC
>70

L90B10
200.000h

<u>References</u>	<u>Puissances</u>	<u>K</u>	<u>Lumens</u>	<u>Dimensions</u>
BPRI571395	13,3W	3000K	2292 Lm	445x775mm
BPRI571388	13,3W	4000K	2399 Lm	445x775mm
BPRI571425	18,8W	3000K	3163 Lm	445x775mm
BPRI571401	18,8W	4000K	3310 Lm	445x775mm
BPRI571449	26,5W	3000K	4239 Lm	445x775mm
BPRI571449	26,5W	4000K	4437 Lm	445x775mm
BPRI571555	34,3W	3000K	6113 Lm	445x775mm
BPRI571548	34,3W	4000K	6397 Lm	445x775mm
BPRI571463	38,8W	3000K	5700 Lm	445x775mm
BPRI571456	38,8W	4000K	5965 Lm	445x775mm
BPRI571579	49,2W	3000K	8435 Lm	445x775mm
BPRI571562	49,2W	4000K	8828 Lm	445x775mm
BPRI571517	51,7W	3000K	8479 Lm	445x775mm
BPRI571500	51,7W	4000K	8873 Lm	445x775mm
BPRI571593	68,7W	3000K	11305 Lm	445x775mm
BPRI571586	68,7W	4000K	11831 Lm	445x775mm
BPRI571531	74,6W	3000K	11400 Lm	445x775mm
BPRI571524	74,6W	4000K	11930 Lm	445x775mm
BPRI571609	78,8W	3000K	12098 Lm	445x775mm
BPRI571609	78,8W	4000K	13242 Lm	445x775mm

ELLP XS



<u>Puissance</u>	12W – 78W ⚡
<u>Couleur de Température (K)</u>	3000K 4000K 🌞
<u>Lumens</u>	1856 - 11200 Lm 💡
<u>Dimensions</u>	620x260x260mm 📏
<u>Options</u>	DALI ✓ DALI/PUSH ✓ ⚡

IP
66

IRC
>70

L90B10
200.000h

References	Puissances	K	Lumens	Dimensions
BIDEELPS16105NM3VM09	39W	4000K	5600 Lm	620x260x260mm
BIDEELPS26105NM3VM09	78W	4000K	11200 Lm	620x260x260mm
BIDEELPS28040NM3VM09	38W	4000K	6080 Lm	620x260x260mm
BIDEELPS51	15,5W	3000K/4000K	2360 Lm	620x260x260mm
BIDEELPS52	25,5W	3000K/4000K	3570 Lm	620x260x260mm
BIDEELPS53	33W	3000K/4000K	4420 Lm	620x260x260mm
BIDEELPS512	39W	3000K/4000K	5060 Lm	620x260x260mm
BIDEELPS55	31W	3000K/4000K	4720 Lm	620x260x260mm
BIDEELPS56	51W	3000K/4000K	7140 Lm	620x260x260mm
BIDEELPS57	66W	3000K/4000K	8840 Lm	620x260x260mm
BIDEELPS514	78W	3000K/4000K	10120 Lm	620x260x260mm
BIDEELPS513	54W	3000K/4000K	7560 Lm	620x260x260mm
BIDEELPS510	72,5W	3000K/4000K	10104 Lm	620x260x260mm
BIDEELPS516	62W	3000K/4000K	8870 Lm	620x260x260mm
BIDEELPS531	24W	3000K/4000K	3713 Lm	620x260x260mm
BIDEELPS551	32W	3000K/4000K	4946 Lm	620x260x260mm
BIDEELPS54	35W	3000K/4000K	5216 Lm	620x260x260mm
BIDEELPS59	46,5W	3000K/4000K	6970 Lm	620x260x260mm
BIDEELPS51	12W	3000K/4000K	1856 Lm	620x260x260mm
BIDEELPS52	17,5W	3000K/4000K	2610 Lm	620x260x260mm
BIDEELPS53	25,5W	3000K/4000K	3570 Lm	620x260x260mm
BIDEELPS58	24W	3000K/4000K	3713 Lm	620x260x260mm

ELLP M & XL

IRC
>70

IP
66

L90B10
100.000h

<u>Puissance</u>	48W – 78,8W ⚡
<u>Couleur de Température (K)</u>	4000K 🌞
<u>Lumens</u>	2399 - 12654 Lm 💡
<u>Dimensions</u>	675x260x305mm 📏
<u>Options</u>	DALI ✓ DALI/PUSH ✓ ⚡



<u>References</u>	<u>Puissances</u>	<u>K</u>	<u>Lumens</u>	<u>Dimensions</u>
BIDEELPM38105NM3VM09	156W	4000K	22440 Lm	675x260x305mm
BIDEELPM28105NM3VM09	104W	4000K	14960 Lm	675x260x305mm
BIDEELPS58	88W	3000K/4000K	11810 Lm	675x260x305mm
BIDEELPS561	48W	3000K/4000K	7420 Lm	675x260x305mm
BIDEELPS510	70W	3000K/4000K	10454 Lm	675x260x305mm
BIDEELPS517	100W	3000K/4000K	14256 Lm	675x260x305mm
BIDEELPS522	140W	3000K/4000K	19500 Lm	675x260x305mm
BIDEELPS511	99W	3000K/4000K	12930 Lm	675x260x305mm
BIDEELPS510	63,5W	3000K/4000K	9821 Lm	850x280x365mm
BIDEELPS521	93W	3000K/4000K	13900 Lm	850x280x365mm
BIDEELPS523	134W	3000K/4000K	19000 Lm	850x280x365mm
BIDEELPS524	200W	3000K/4000K	25917 Lm	850x280x365mm

IRC
>80

IP
66

UGR
>26

L90B10
100.000h

<u>Puissance</u>	13,3W – 78,8W ⚡
<u>Couleur de Température (K)</u>	2700K-3000K-4000K-6000K
<u>Lumens</u>	10000 - 78000 Lm 💡
<u>Dimensions</u>	330x268 412x360 622x520mm 📏
<u>Options</u>	DALI ✓ DALI/PUSH ✓ ⚡

References	Puissances	K	Lumens	Dimensions
BIDE917011	30W/50W/75W/100W	3000-4000-6000K	10000 Lm	330x268x48mm
BIDE917012	60W/100W/150W/200W	3000-4000-6000K	20000 Lm	412x360x54mm
BIDE917020	60W/100W/150W/200W	3000-4000-6000K	28000 Lm	412x360x54mm
BIDE917013	200W/400W/500W/600W	2700-4000-6000K	78000 Lm	622x520x63mm

BIDE917011



BIDE917012



BIDE917020



BIDE917013



GRENOBLE



<u>Puissance</u>	40W ⚡
<u>Couleur de Température (K)</u>	3000K 🌞
<u>Lumens</u>	6000 Lm 💡
<u>Dimensions</u>	Ø422x539mm
<u>Options</u>	DALI ✓ DALI/PUSH ✓ ⚡

IRC
>70

IP
66

L90B10
50.000h

<u>References</u>	<u>Puissances</u>	<u>K</u>	<u>Lumens</u>	<u>Dimensions</u>
BIDE422001	40W	3000K	6000 Lm	Ø422x539mm

NANTES

<u>Puissance</u>	38W – 118,4W ⚡
<u>Couleur de Température (K)</u>	3000K-4000K 🌞
<u>Lumens</u>	7064 Lm - 18598 Lm 💡
<u>Dimensions</u>	500x250x55mm
<u>Options</u>	DALI ✓ DALI/PUSH ✓ ⚡

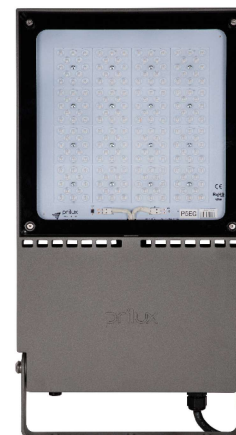

IRC
>70

IP
66

L90B10
100.000h

<u>References</u>	<u>Puissances</u>	<u>K</u>	<u>Lumens</u>	<u>Dimensions</u>
BPRI575454	38W	3000 – 4000K	7064 Lm	500x250x55mm
BPRI519878	38W	3000 – 4000K	7348 Lm	500x250x55mm
BPRI575461	55,1W	3000 – 4000K	9762 Lm	500x250x55mm
BPRI519847	55,1W	3000 – 4000K	10153 Lm	500x250x55mm
BPRI575485	79W	3000 – 4000K	13171 Lm	500x250x55mm
BPRI519892	79W	3000 – 4000K	13698 Lm	500x250x55mm
BPRI575478	118,4W	3000 – 4000K	17881 Lm	500x250x55mm
BPRI519915	118,4W	3000 – 4000K	18598 Lm	500x250x55mm



<u>Puissance</u>	68,8 – 203,7W ⚡
<u>Couleur de Température (K)</u>	3000K – 4000K 🌈
<u>Lumens</u>	12565 Lm – 33070 Lm 💡
<u>Dimensions</u>	560x300x56mm
<u>Options</u>	DALI ✓ DALI/PUSH ✓ ⚡

IRC
>70

IP
66

L70B10
100.000h

<u>References</u>	<u>Puissances</u>	<u>K</u>	<u>Lumens</u>	<u>Dimensions</u>
BPRI575492	68,8W	3000 – 4000K	12565 Lm	560x300x56mm
BPRI519922	68,8W	3000 – 4000K	13069 Lm	560x300x56mm
BPRI571999	98,3W	3000 – 4000K	17355 Lm	560x300x56mm
BPRI520010	98,3W	3000 – 4000K	18239 Lm	560x300x56mm
BPRI575508	137,6W	3000 – 4000K	23413 Lm	560x300x56mm
BPRI520027	137,6W	3000 – 4000K	24350 Lm	560x300x56mm
BPRI575515	203,7W	3000 – 4000K	31798 Lm	560x300x56mm
BPRI520034	203,7W	3000 – 4000K	33070 Lm	560x300x56mm

NANTES XL

<u>Puissance</u>	104W – 324,1W ⚡
<u>Couleur de Température (K)</u>	3000K-4000K 🌈
<u>Lumens</u>	9654 Lm – 51672 Lm 💡
<u>Dimensions</u>	650x350x60mm
<u>Options</u>	DALI ✓ DALI/PUSH ✓ ⚡

IRC
>70

IP
66

L70B10
100.000h



<u>References</u>	<u>Puissances</u>	<u>K</u>	<u>Lumens</u>	<u>Dimensions</u>
BPRI575522	104W	3000 – 4000K	9654 Lm	650x350x60mm
BPRI520041	104W	3000 – 4000K	20420 Lm	650x350x60mm
BPRI575546	149,9W	3000 – 4000K	27004 Lm	650x350x60mm
BPRI520058	149,9W	3000 – 4000K	28203 Lm	650x350x60mm
BPRI575539	215,9W	3000 – 4000K	36928 Lm	650x350x60mm
BPRI520065	215,9W	3000 – 4000K	38047 Lm	650x350x60mm
BPRI566681	324,1W	3000 – 4000K	47815 Lm	650x350x60mm
BPRI520072	324,1W	3000 – 4000K	51672 Lm	650x350x60mm

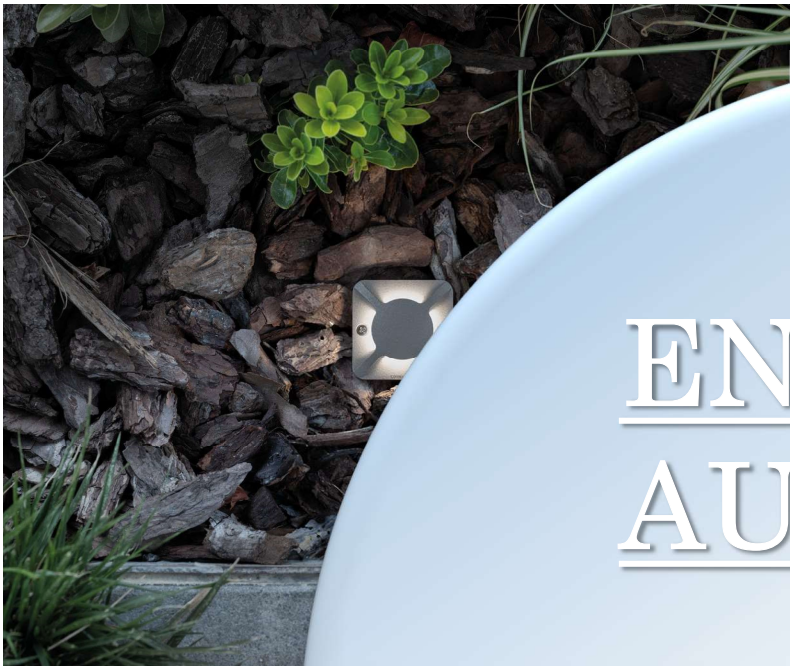
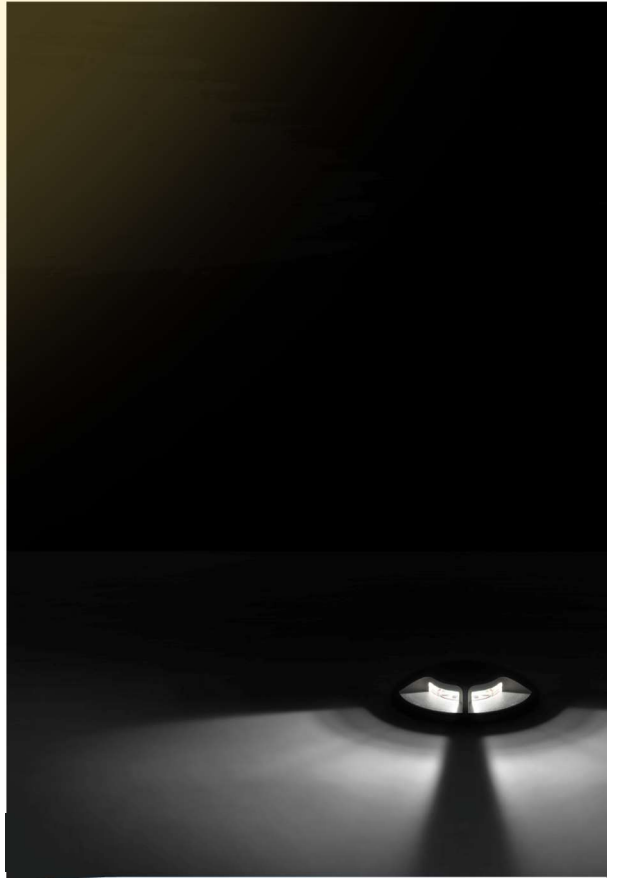

ENCASTRE AU SOL

IRC
>80

L80B20
50.000h

IP
67

<u>Puissance</u>	2W ⚡
<u>Couleur de Température (K)</u>	2700K - 3000K - 4000K 🌈
<u>Lumens</u>	240 Lm 💡
<u>Dimensions</u>	Ø50x45mm 50x50x45mm
<u>Options</u>	DALI ✓ DALI/PUSH ✓ ⚡

BLOMLL12700



BLOMLL12701



BLOMLL12702



BLOMLL12703



BLOMLL12710



BLOMLL12711



BLOMLL12712

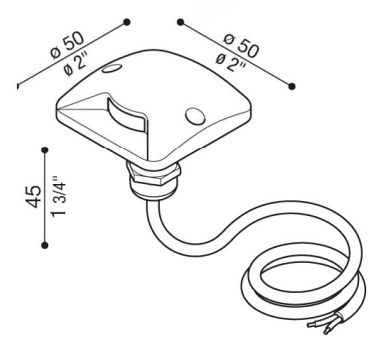
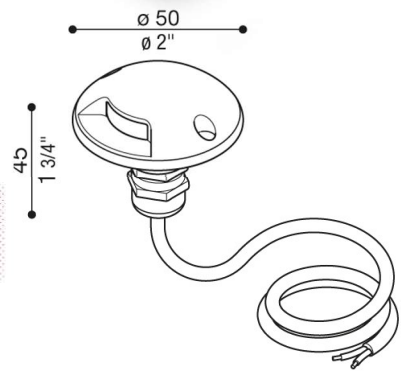

Couleurs : ACIER (0), BLANC (W), GRIS (G), GRIS FONCEE (E), MARRONS (K)

<u>References</u>	<u>Puissances</u>	<u>K</u>	<u>Lumens</u>	<u>Dimensions</u>
BLOMLL12700X	2W	2700 - 3000 - 4000K	240 Lm	Ø50x45mm
BLOMLL12701X	2W	2700 - 3000 - 4000K	240 Lm	Ø50x45mm
BLOMLL12702X	2W	2700 - 3000 - 4000K	240 Lm	Ø50x45mm
BLOMLL12703X	2W	2700 - 3000 - 4000K	240 Lm	Ø50x45mm
BLOMLL12710X	2W	2700 - 3000 - 4000K	240 Lm	50x50x45mm
BLOMLL12711X	2W	2700 - 3000 - 4000K	240 Lm	50x50x45mm
BLOMLL12712X	2W	2700 - 3000 - 4000K	240 Lm	50x50x45mm

IRC
>80

L80B20
50.000h

IP
67

Puissance	5W ⚡
Couleur de Température (K)	2700K - 3000K - 4000K 🌈
Lumens	470 Lm 💡
Dimensions	Ø100x50mm 100x100x50mm
Options	DALI ✓ DALI/PUSH ✓ ⚡

BLOMLL13700



BLOMLL13701



BLOMLL13702



BLOMLL13703



BLOMLL13704



BLOMLL13710



BLOMLL13711



BLOMLL13712



Couleurs : BLANC (W), GRIS (G), GRIS FONCEE (E), MARRONS (K)

Couleurs : ACIER (0) BLOMLL13700 - BLOMLL13701 - BLOMLL13702 - BLOMLL13703 - BLOMLL13704

References	Puissances	K	Lumens	Dimensions
BLOMLL13700X	5W	2700 - 3000 - 4000K	470 Lm	Ø100x50mm
BLOMLL13701X	5W	2700 - 3000 - 4000K	470 Lm	Ø100x50mm
BLOMLL13702X	5W	2700 - 3000 - 4000K	470 Lm	Ø100x50mm
BLOMLL13703X	5W	2700 - 3000 - 4000K	470 Lm	Ø100x50mm
BLOMLL13704X	5W	2700 - 3000 - 4000K	470 Lm	Ø100x50mm
BLOMLL13710X	5W	2700 - 3000 - 4000K	470 Lm	100x100x50mm
BLOMLL13711X	5W	2700 - 3000 - 4000K	470 Lm	100x100x50mm
BLOMLL13712X	5W	2700 - 3000 - 4000K	470 Lm	100x100x50mm

CNC 120



<u>Puissance</u>	9W ⚡
<u>Couleur de Température (K)</u>	2700K - 3000K - 4000K 🌈
<u>Lumens</u>	1000 Lm 💡
<u>Dimensions</u>	Ø120x80mm
<u>Options</u>	DALI ✓ DALI/PUSH ✓ ➡

L80B20
50.000h

IP
67

IRC
>80

BLOMLL13100 = 700MA – 12V | BLOMLL13110 = 12/24V

<u>References</u>	<u>Puissances</u>	<u>K</u>	<u>Lumens</u>	<u>Dimensions</u>
BLOMLL13100	9W	2700 - 3000 - 4000K	1000 Lm	Ø120x80mm
BLOMLL13110	9W	2700 - 3000 - 4000K	1000 Lm	Ø120x80mm

CNC 150

<u>Puissance</u>	20W ⚡
<u>Couleur de Température (K)</u>	2700K - 3000K - 4000K 🌈
<u>Lumens</u>	2800 Lm 💡
<u>Dimensions</u>	Ø150x80mm
<u>Options</u>	DALI ✓ DALI/PUSH ✓ ➡



L80B20
50.000h

IP
67

IRC
>80

<u>References</u>	<u>Puissances</u>	<u>K</u>	<u>Lumens</u>	<u>Dimensions</u>
BLOMLL13600	20W	2700 - 3000 - 4000K	1000 Lm	Ø120x80mm

Puissance | 2W ⚡

Couleur de Température (K) | 2700K - 3000K - 4000K 🌈

Lumens | 180 Lm 💡

Dimensions

Ø35x49 | 35x35x54 | Ø35x54 | Ø26x49x58 | Ø35x59 | 35x35x59
Ø26x28x69

Options | DALI ✓ | DALI/PUSH ✓ ⚡

L80B20
50.000h

BLOMLL10728
BLOMLL10729



IRC
>80

BLOMLL10700
BLOMLL10706



BLOMLL10701
BLOMLL10707



BLOMLL10702
BLOMLL10708



BLOMLL10703
BLOMLL10709



BLOMLL10704
BLOMLL10710



BLOMLL10705
BLOMLL10711



BLOMLL10724
BLOMLL10725



BLOMLL10726
BLOMLL10727

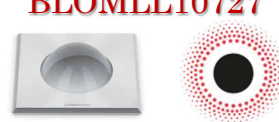

500MA – 4,8V | 12/24V

Couleurs : GRIS FONCEE (E), MARRONS (K)

<u>References</u>	<u>Puissances</u>	<u>K</u>	<u>Lumens</u>	<u>Dimensions</u>
BLOMLL10700X	2W	2700 - 3000 - 4000K	180 Lm	Ø35x49mm
BLOMLL10706X	2W	2700 - 3000 - 4000K	180 Lm	Ø35x49mm
BLOMLL10701	2W	2700 - 3000 - 4000K	180 Lm	35x35x54mm
BLOMLL10707	2W	2700 - 3000 - 4000K	180 Lm	35x35x54mm
BLOMLL10702	2W	2700 - 3000 - 4000K	180 Lm	Ø35x54mm
BLOMLL10708	2W	2700 - 3000 - 4000K	180 Lm	Ø35x54mm
BLOMLL10703	2W	2700 - 3000 - 4000K	180 Lm	Ø35x54mm
BLOMLL10709	2W	2700 - 3000 - 4000K	180 Lm	Ø35x54mm
BLOMLL10704	2W	2700 - 3000 - 4000K	180 Lm	Ø35x54mm
BLOMLL10710	2W	2700 - 3000 - 4000K	180 Lm	Ø35x54mm
BLOMLL10705X	2W	2700 - 3000 - 4000K	180 Lm	Ø26x49x58mm
BLOMLL10711X	2W	2700 - 3000 - 4000K	180 Lm	Ø26x49x58mm
BLOMLL10724	2W	2700 - 3000 - 4000K	180 Lm	Ø35x59mm
BLOMLL10725	2W	2700 - 3000 - 4000K	180 Lm	Ø35x59mm
BLOMLL10726	2W	2700 - 3000 - 4000K	180 Lm	35x35x59mm
BLOMLL10727	2W	2700 - 3000 - 4000K	180 Lm	35x35x59mm
BLOMLL10728	2W	2700 - 3000 - 4000K	180 Lm	Ø26x58x69mm
BLOMLL10728	2W	2700 - 3000 - 4000K	180 Lm	Ø26x58x69mm

AGO GARDEN



<u>Puissance</u>	6W ⚡
<u>Couleur de Température (K)</u>	2200K - 2700K - 3000K - 4000K 🌈
<u>Lumens</u>	700 Lm 💡
<u>Dimensions</u>	Ø50x72x345mm
<u>Options</u>	DALI ✓ DALI/PUSH ✓ ⚙️

L80B50
50.000h

IRC
>80

IP
66

BLOMLL12600 = AC DIRECT | BLOMLL12601 = 24V

Couleurs : GRIS (G), NOIR (N), VERT (V), MARRON (K)

<u>References</u>	<u>Puissances</u>	<u>K</u>	<u>Lumens</u>	<u>Dimensions</u>
BLOMLL12600	6W	2200 - 2700 - 3000 - 4000K	700 Lm	Ø50x72x345mm
BLOMLL12601	6W	2200 - 2700 - 3000 - 4000K	700 Lm	Ø50x72x345mm

AGO GARDEN POWER

<u>Puissance</u>	10W ⚡
<u>Couleur de Température (K)</u>	2200K - 2700K - 3000K - 4000K 🌈
<u>Lumens</u>	1100 Lm 💡
<u>Dimensions</u>	Ø50x106x345mm
<u>Options</u>	DALI ✓ DALI/PUSH ✓ ⚙️

L80B50
50.000h

IRC
>80

IP
66



BLOMLL12602 = AC DIRECT | BLOMLL12603 = 24V

Couleurs : GRIS (G), NOIR (N), VERT (V), MARRON (K)

<u>References</u>	<u>Puissances</u>	<u>K</u>	<u>Lumens</u>	<u>Dimensions</u>
BLOMLL12602	6W	2200 - 2700 - 3000 - 4000K	700 Lm	Ø50x72x345mm
BLOMLL12603	6W	2200 - 2700 - 3000 - 4000K	700 Lm	Ø50x72x345mm

SWING SPOT



<u>Puissance</u>	2W ⚡
<u>Couleur de Température (K)</u>	2700K - 3000K - 4000K
<u>Lumens</u>	700 Lm 💡
<u>Dimensions</u>	Ø26x69x58mm
<u>Options</u>	DALI ✓ DALI/PUSH ✓ ⚡

L80B20
50.000h

IRC
>80

IP
67

BLOMLL10702 = 500MA – 4.8V | BLOMLL10709 = 12/24V

<u>References</u>	<u>Puissances</u>	<u>K</u>	<u>Lumens</u>	<u>Dimensions</u>
BLOMLL10702	2W	2700 - 3000 - 4000K	180 Lm	Ø26x69x58mm
BLOMLL10709	2W	2700 - 3000 - 4000K	180 Lm	Ø26x69x58mm

SWING SPOT POWER

<u>Puissance</u>	6,5W ⚡
<u>Couleur de Température (K)</u>	2200K - 2700K - 3000K - 4000K
<u>Lumens</u>	1100 Lm 💡
<u>Dimensions</u>	Ø50x106x345mm
<u>Options</u>	DALI ✓ DALI/PUSH ✓ ⚡



L80B20
50.000h

IRC
>80

IP
67

BLOMLL10703 = 500MA | BLOMLL10731 = 24V

<u>References</u>	<u>Puissances</u>	<u>K</u>	<u>Lumens</u>	<u>Dimensions</u>
BLOMLL10703	6,5W	2700 - 3000 - 4000K	650 Lm	Ø42x106x66mm
BLOMLL10731	6,5W	2700 - 3000 - 4000K	650 Lm	Ø42x106x66mm